



**TTB3450 / 100S,
TTB 4552 / 100S
& TTB 4500 / 100S**
SCRUBBER DRIER
**OPERATING INSTRUCTIONS
& SPARE PARTS**
(Battery operated machines)



Original Instructions
Warning! read instructions before using machine.

IMPORTANT!

FUSE FITTING INSTRUCTIONS

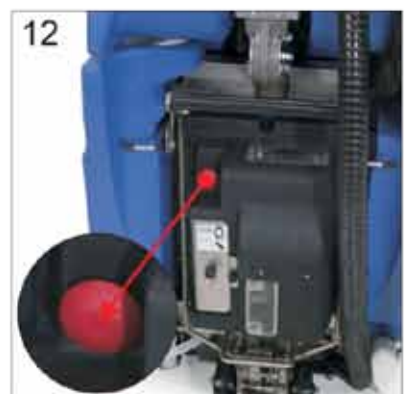
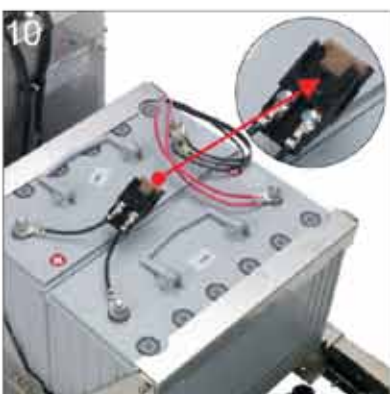



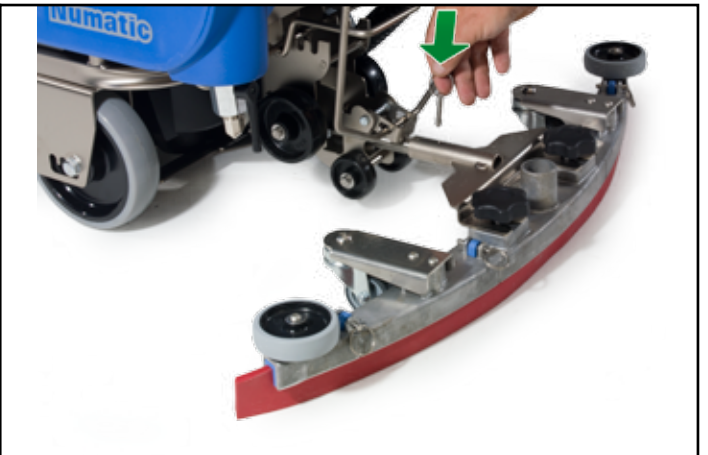
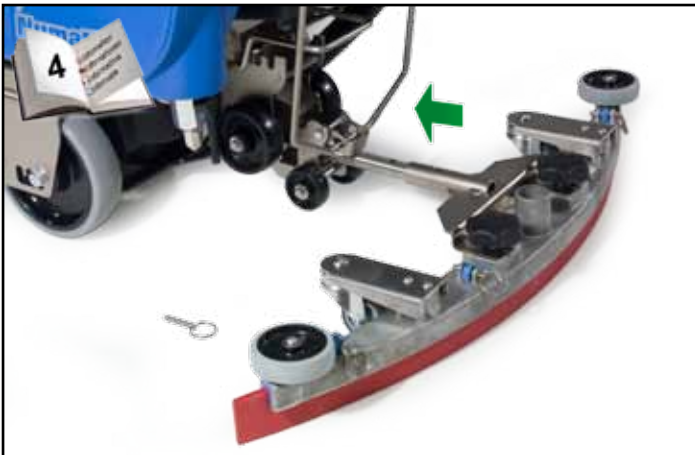

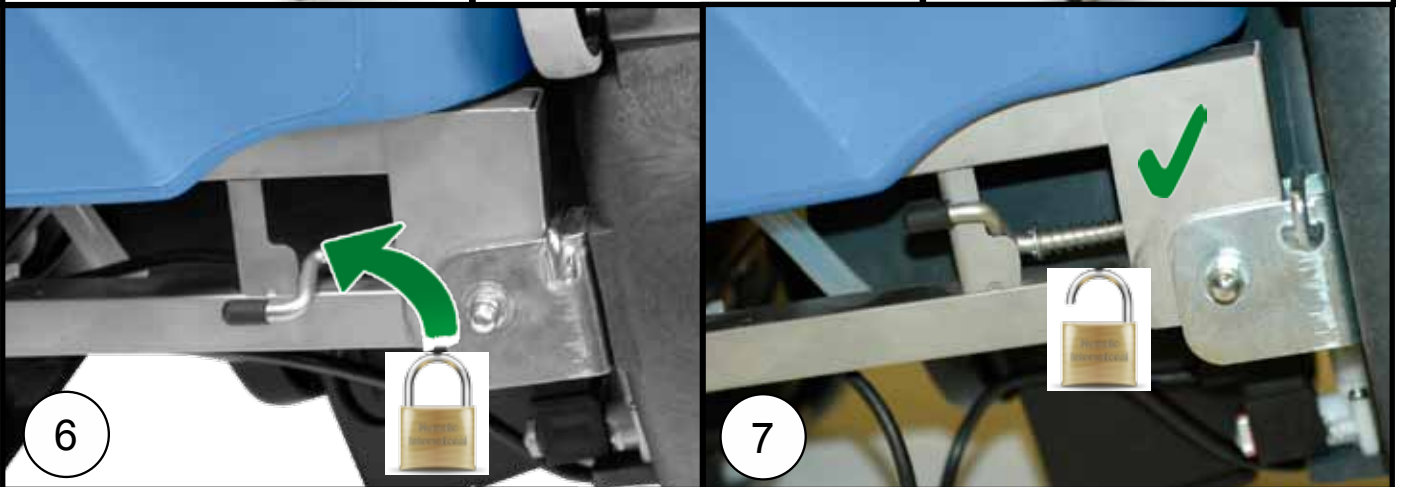
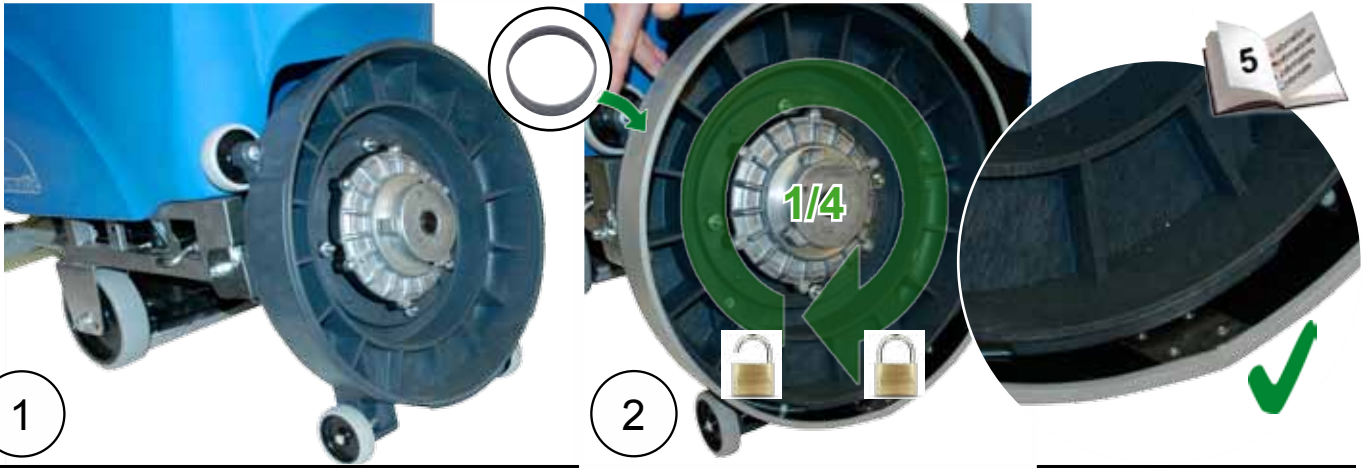

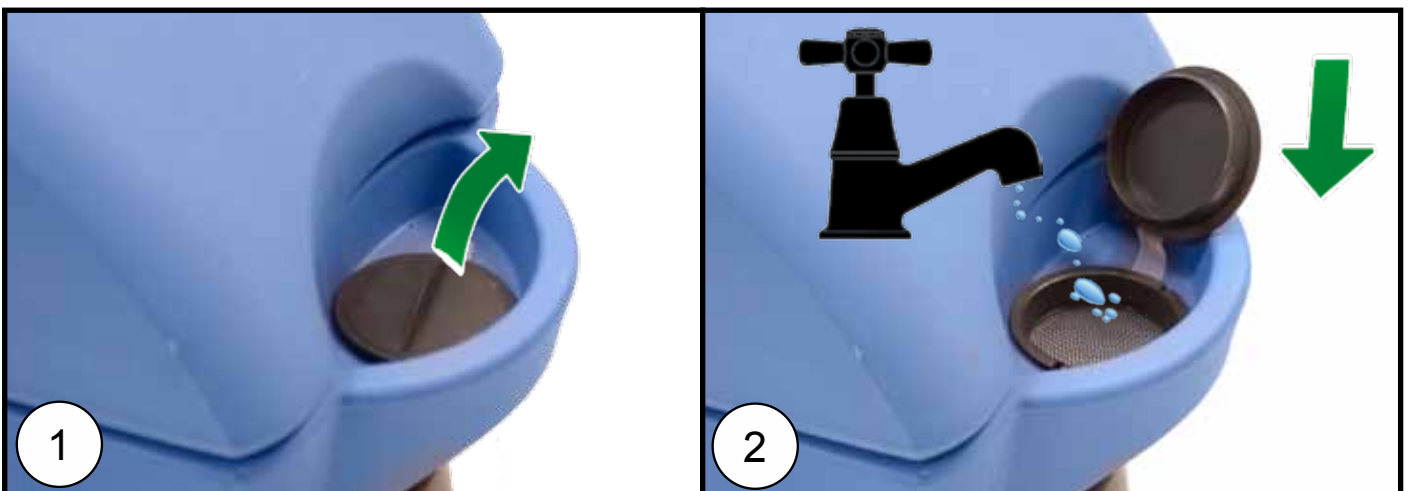
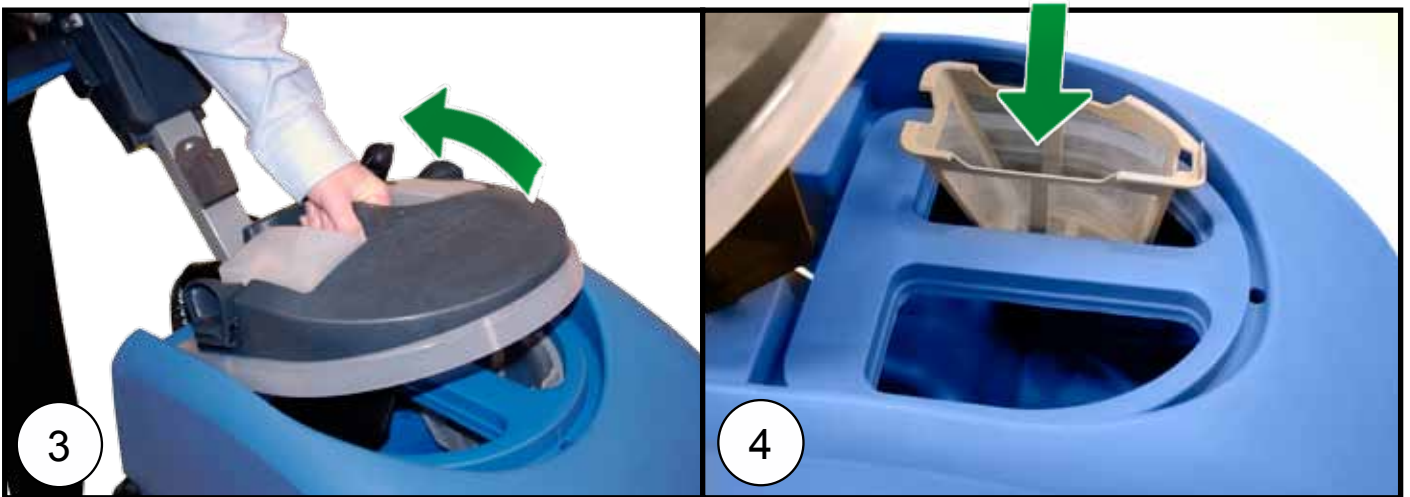
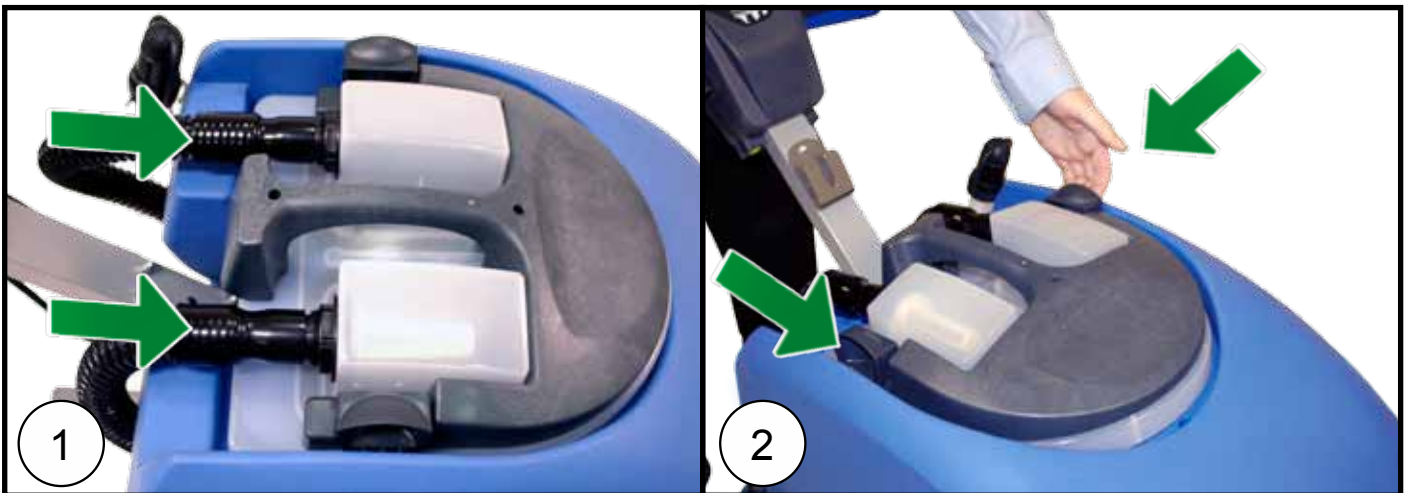
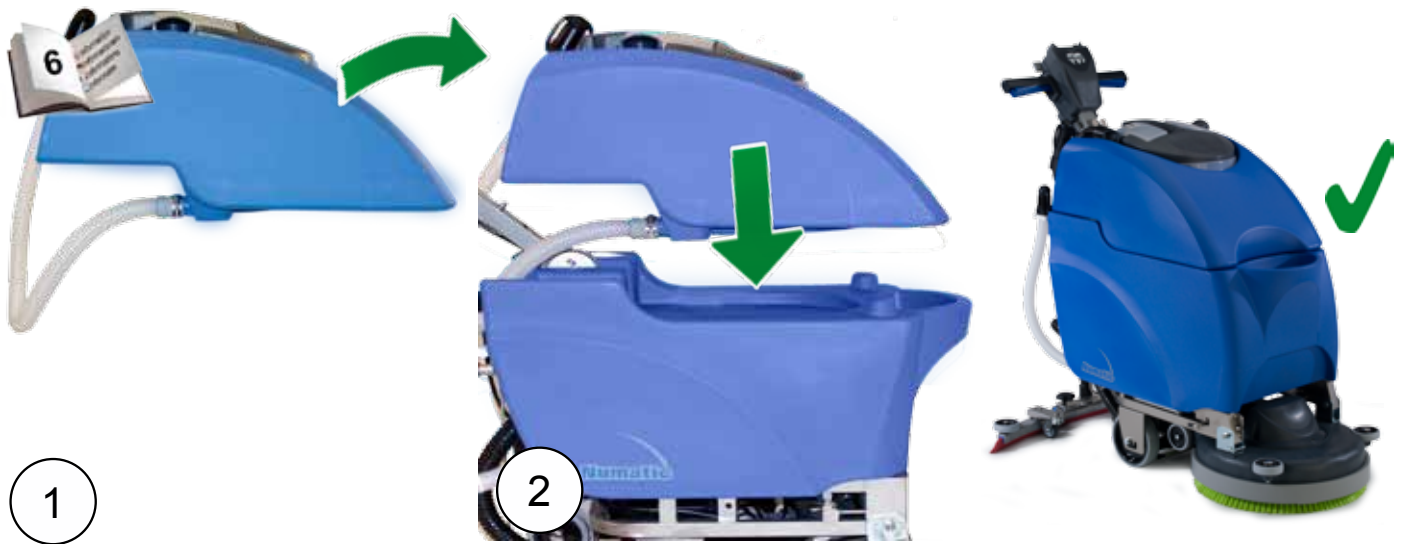

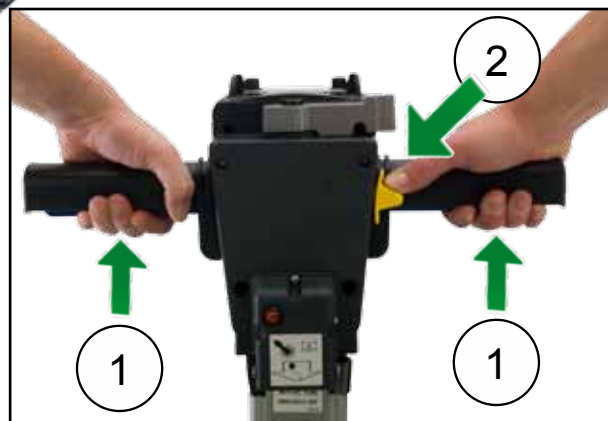
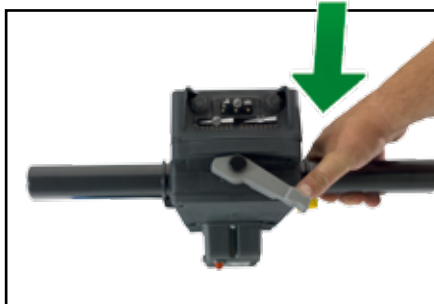



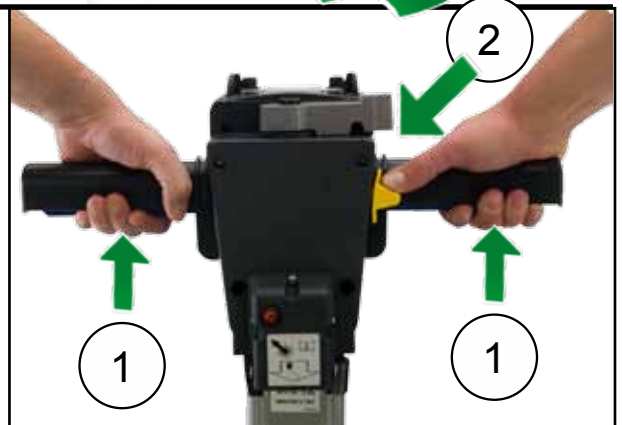
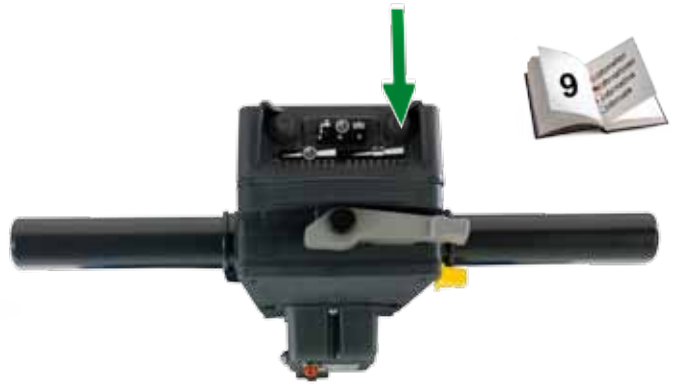



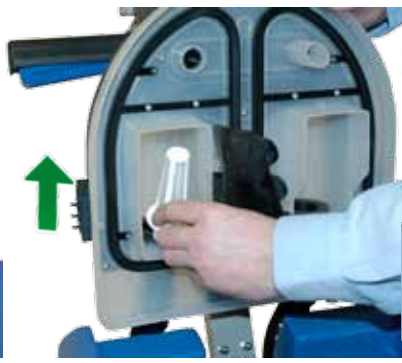

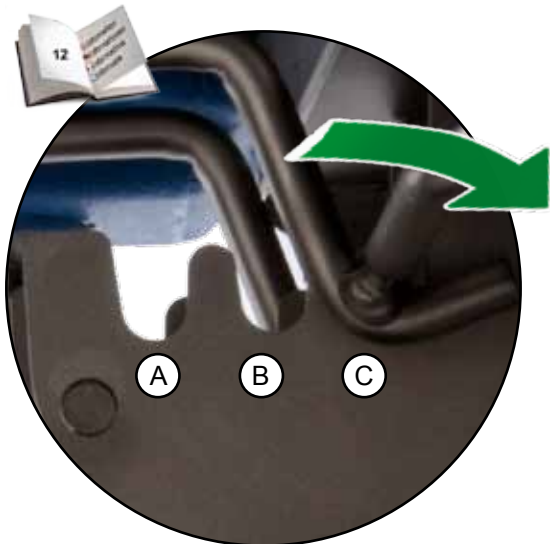

Ⓐ = 28 Kg

Ⓑ = 30 Kg

Ⓒ = 32 Kg

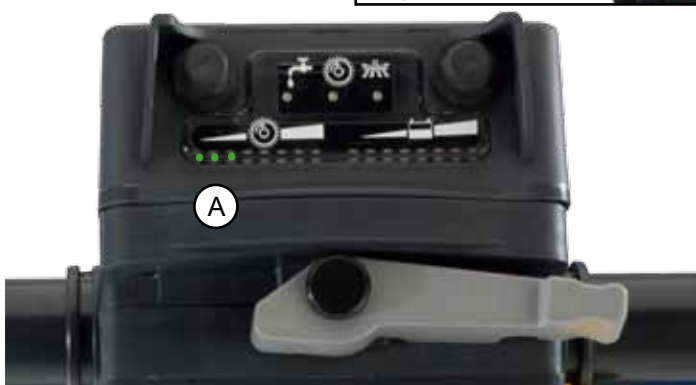
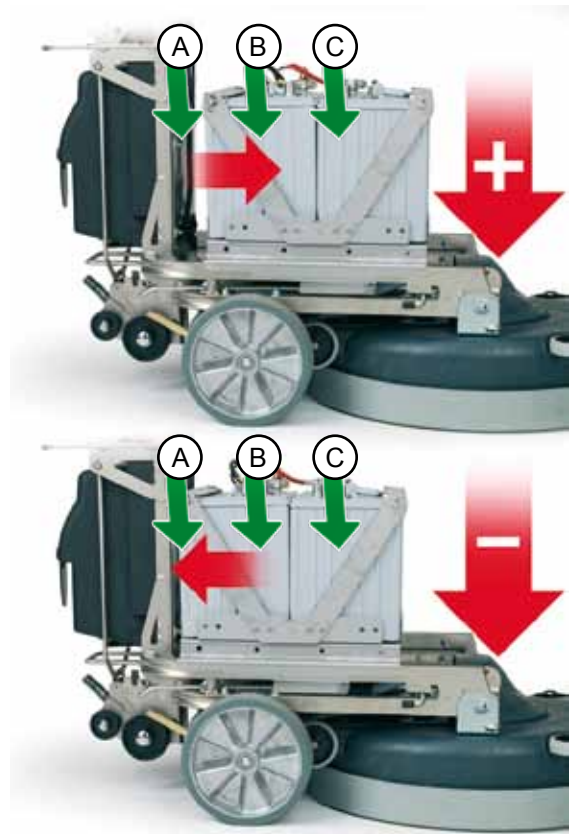



?

=

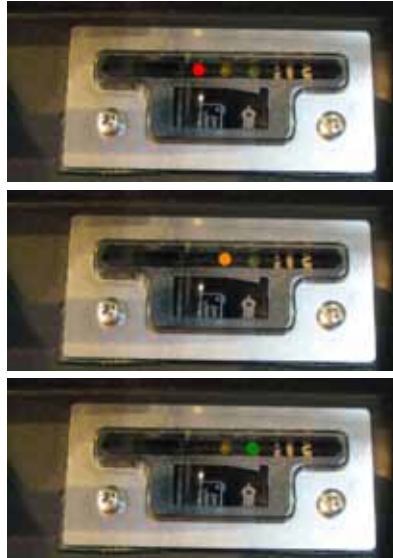
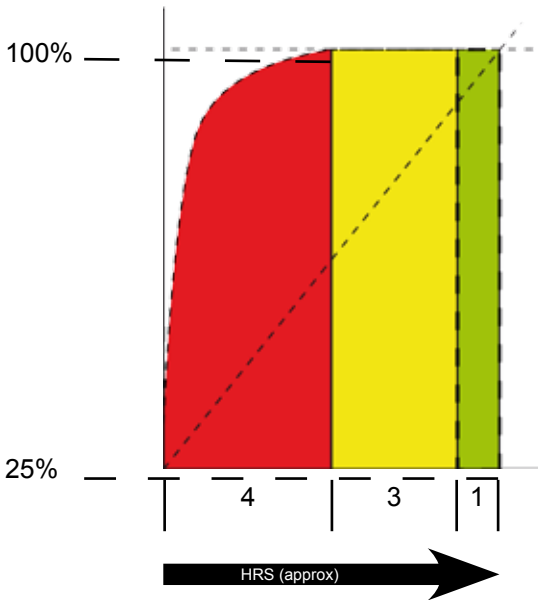

=



=

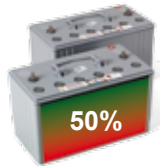

=

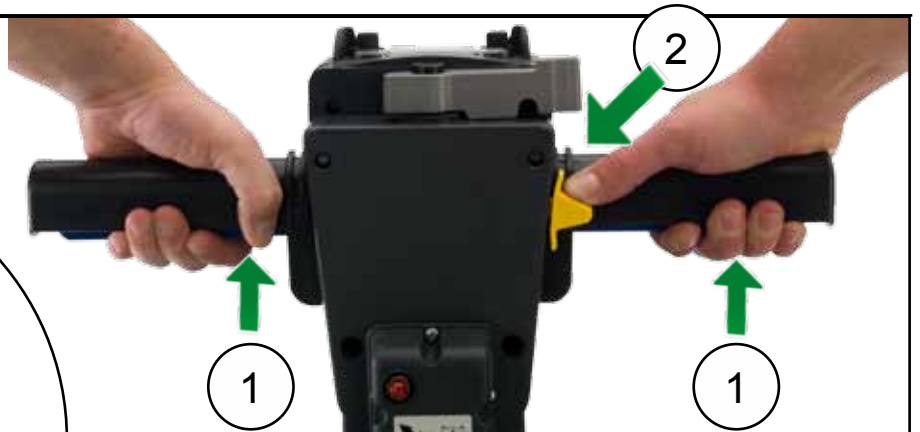
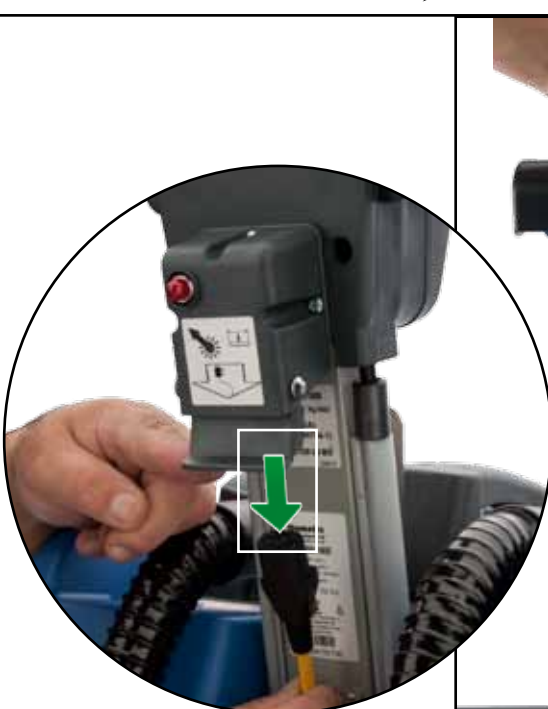

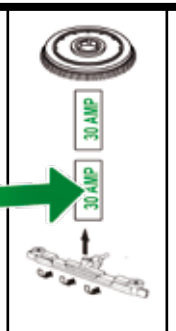
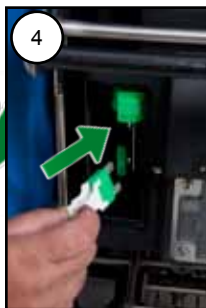
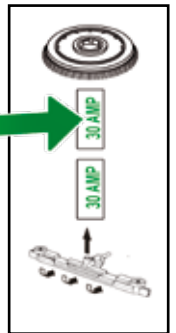

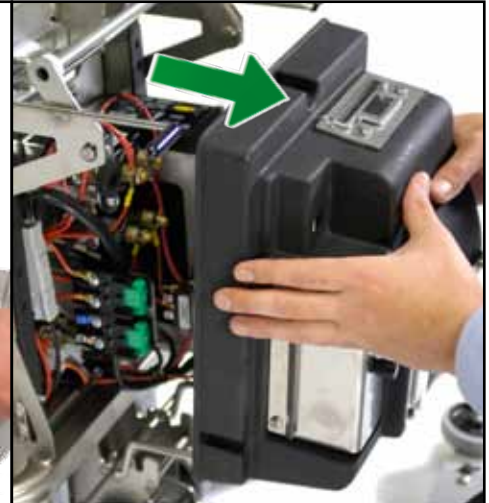
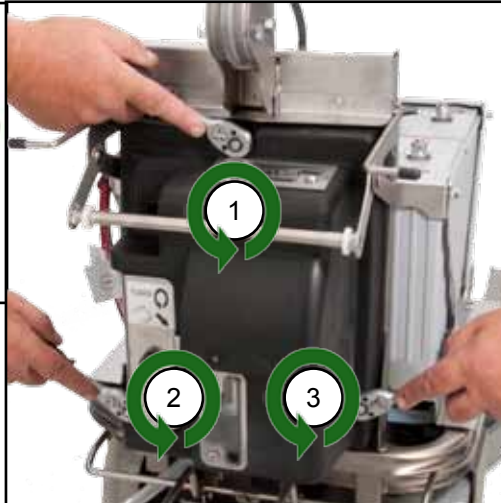
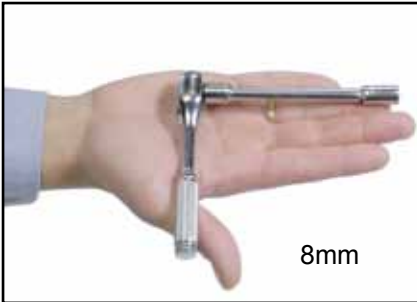

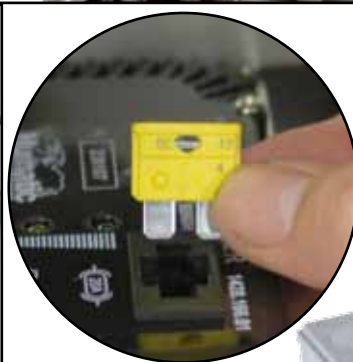
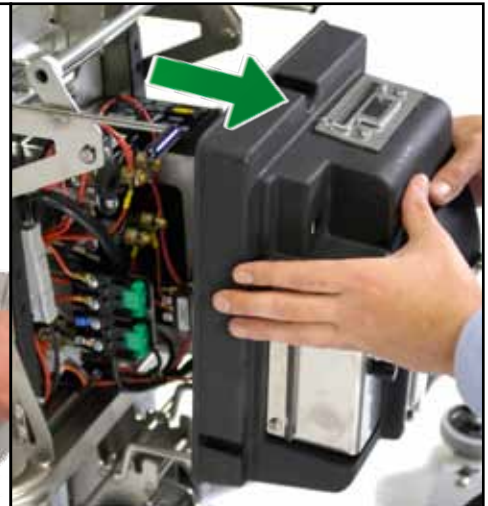
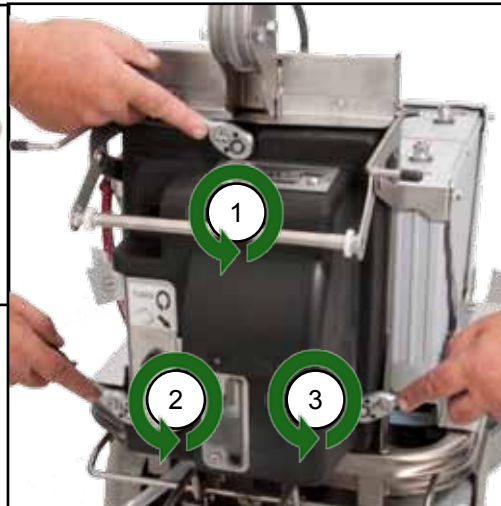
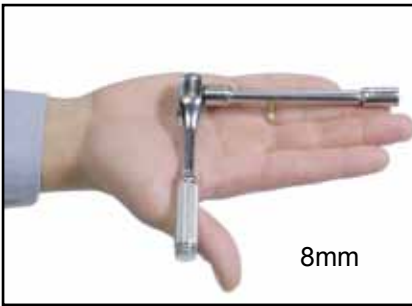
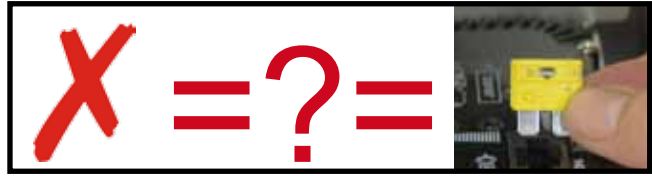

**Changing the Floor Tool Blades, Auswechseln der Blätter des Bodenwerkzeugs
De rubbers van de zuigmond vervangen, Remplacement des lamelles du suceur.**

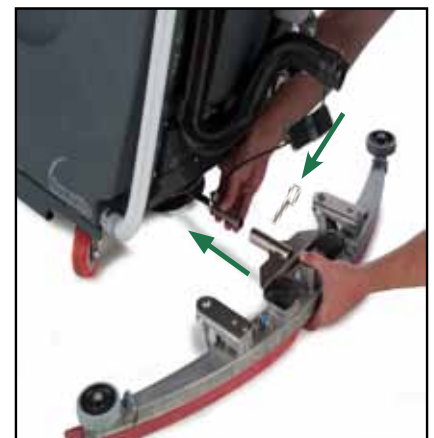
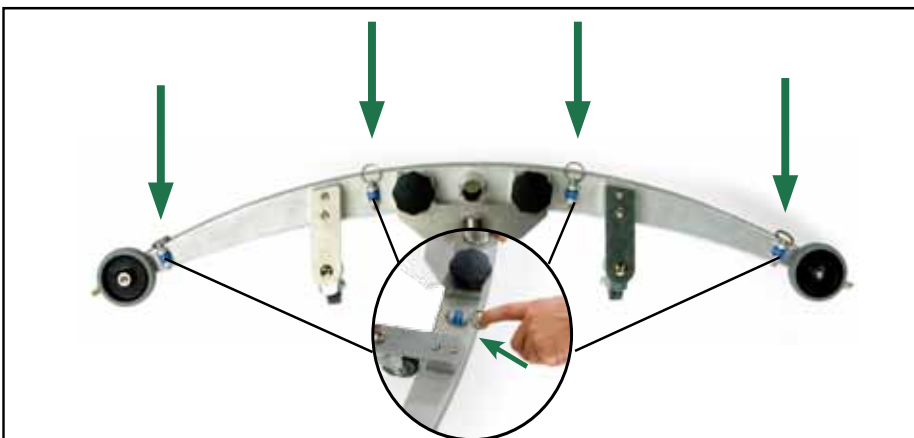
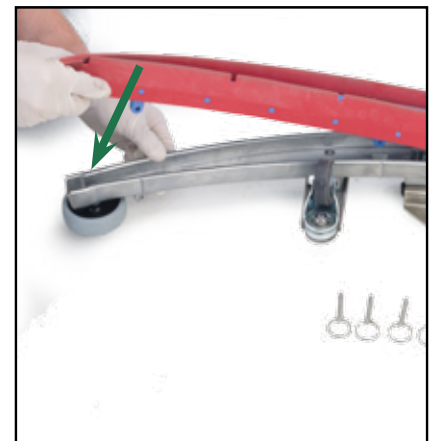
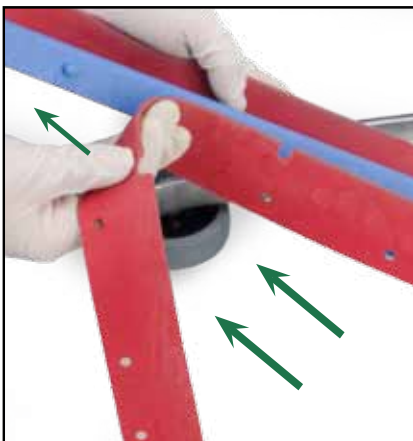
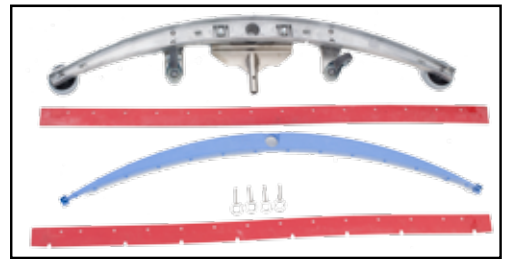
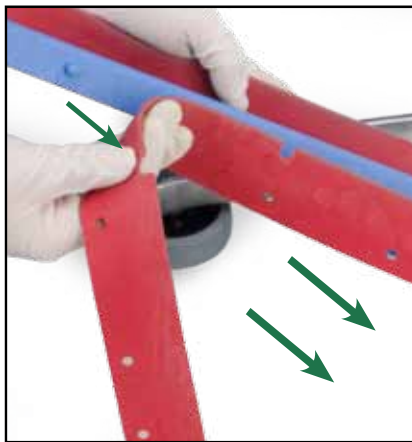
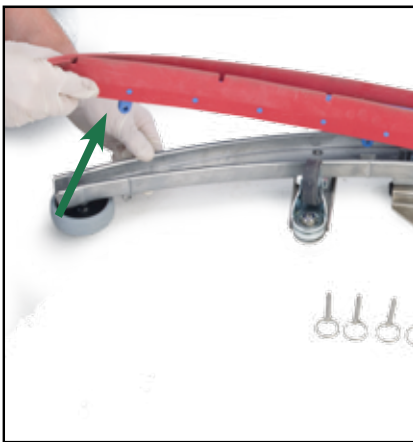
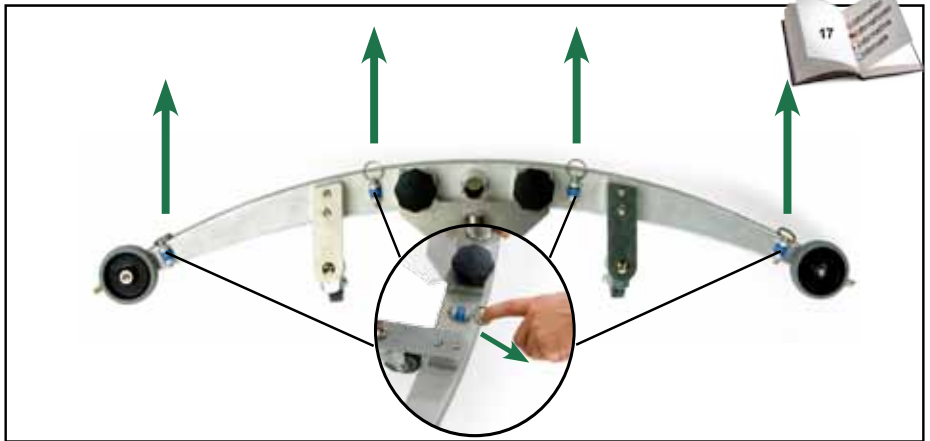



About the Machine

Rating Label

Numatic — Company name and address
 International Ltd
 CHARD, ENGLAND, TA20 2GB

TTB XXXXX — Machine Description

BATTERY 24V -
 CHARGING SUPPLY — Voltage Frequency
 220-240v~ 400w 50Hz
 OUTPUT 10 AMPS -

2% **XXX Kg** — Weight

CE Mark

WEEE Logo

DISCONNECT THE SUPPLY
 BEFORE MAKING OR
 BREAKING CONNECTIONS
 TO THE BATTERY

Machine yr/ wk / serial number
 100621036

WEEE (Waste, Electrical and Electronic Equipment)



Scrubber Drier Accessories and Packaging should be sorted for Environmental- Friendly recycling. Only for EU countries.

Do not dispose of Scrubber drier into household waste. According to the European directive 2002/96/EC on waste electrical electronic equipment and its incorporation into national law.

Scrubber driers that are no longer suitable for use must be separated collected and sent for recovery in an Environmental- friendly manner.

TTB XXXXS — Machine Description

WEIGHT XXX Kg MAX — Weight

NOISE — Noise Level
 WITH VAC **XX dB(A)**

HAV xx m/s² — Hand Arm Vibration

Safety Critical Component

Mains Lead: H05VV-F x 1.5mm² x 3 core

PPE (Personal protective equipment) that maybe required for certian operations.

Ear Protection	Safety Footwear	Head Protection	Safety Gloves	Dust/Allergens Protection	Eye Protection	Protective Clothing



Caution Floorsign

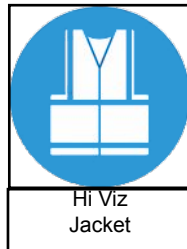

Note:
 A risk assessment should be conducted to decide what PPE should be worn.

Component	Interval	Inspect for
Mains Lead	DAILY	scuffing, cracks, splits, conductors showing
Brushes	DAILY	bristle damage, wear, drive collar wear
Squeegee Blade	BEFORE EACH USE	wear, cracks, splits
Filters	BEFORE EACH USE	clogging and debris retention
Tanks	AFTER EACH USE	rinse dirty water tank after use



TTB 3450 / 100S

Brush Motor	Vac Motor	Power	Sound Pressure	Speed	Brush	Pad
400W	400W	GELL BATTERY 24V (2 X 12 V) = 100A/Hr	73 dB(A)	120rpm	450mm	400mm
Gross Weight Full	Protection Class	Hand Arm Vibration	Dimensions	Net Weight	Water Capacity	
152 Kg	Class 1	0.4 +/- 0.05ms ²	1150x930x790	122 Kg	30 L	



TTB4552 / 100S

Brush Motor	Vac Motor	Power	Sound Pressure	Speed	Brush	Pad
2 x 400W	400W	GELL BATTERY 24V (2 X 12 V) = 100A/Hr	70 dB(A)	120rpm	2 x 280mm	2 x 280mm
Gross Weight Full	Protection Class	Hand Arm Vibration	Dimensions	Net Weight	Water Capacity	
166 Kg	Class 1	0.7 +/- 0.05ms ²	1150x930x850	126 Kg	40 L	



TTB 4500 / 100S

Brush Motor	Vac Motor	Power	Sound Pressure	Speed	Brush	Pad
400W	400W	GELL BATTERY 24V (2 X 12 V) = 100A/Hr	74 dB(A)	120rpm	500mm	450mm
Gross Weight Full	Protection Class	Hand Arm Vibration	Dimensions	Net Weight	Water Capacity	
154 Kg	Class 1	0.5 +/- 0.05ms ²	1150x960x850	124 Kg	40 L	



ORIGINAL INSTRUCTIONS
READ MANUAL BEFORE USE

Information for Scrubber Drier

Means:-

CAUTION:

Read the instruction manual before using the appliance.

This product meets the requirements of BS. EN 60335-2-72

WARNING:

As with all electrical equipment care and attention must be exercised at all times during its use, in addition to ensuring that routine and preventative maintenance is carried out periodically in order to ensure its safe operation. Failure to carry out maintenance as necessary, including the replacement of parts to the correct standard could render this equipment unsafe and the manufacturer can accept no responsibility or liability in this respect.

When ordering spare parts always quote the Model Number / Serial Number specified on the Rating Plate.

Warning do not use on slopes.

NOTE:

This machine is also suitable for commercial use, for example in hotels, schools, hospitals, factories, shops and offices for other than normal housekeeping purposes.

CAUTION:

This machine is not suitable for picking up hazardous dust.

Do not use on surfaces having a gradient exceeding that marked on the appliance.

The machine is not to be stored outdoors in wet conditions.

This machine is for indoor use only.

Do's and Don'ts:

DO ensure only competent persons unpack/assemble the machine.

DO keep your machine clean.

DO keep your brushes in good condition.

DO replace any worn or damaged parts immediately.

DO regularly examine the power cord for damage, such as cracking or ageing. If damage is found, replace the cord before further use.

DO only replace the power cord with the correct Numatic approved replacement parts.

DO ensure that the work area is clear of obstructions and / or people.

DO ensure that the working area is well illuminated.

DO pre-sweep the area to be cleaned.

DON'T use steam cleaners or pressure washers to clean the machine or use in the rain.

DON'T attempt machine maintenance or cleaning unless the power plug has been removed from the supply outlet.

DON'T allow any inexperienced repairs. Call the experts

DON'T strain cable or try to unplug by pulling on cable.

DON'T leave the brush pad on the machine when not in use.

DON'T allow the machine to be used by inexperienced or unauthorised operators or without appropriate training.

DON'T use the machine without the solution tanks properly positioned on the machine, as shown in the instructions.

DON'T expect the machine to provide trouble-free, reliable operation unless maintained correctly.

DON'T run the machine over power cable during operation.

DON'T lift or pull the machine by any of the operating triggers - Use the main handle.

DON'T remove the handle from the machine except for service and repair.

Warning:

Only use brushes provided with the appliance or those specified in the instruction manual.

The use of other brushes may impair safety.

A full range of brushes and accessories are available for this product.

Only use brushes or pads which are suitable for the correct operation of the machine for the specific task being performed.

Ensure machine is switched OFF when not in use.

Warning:

It is essential that this equipment is correctly assembled and operated in accordance with current safety regulations.

When using the equipment always ensure that all necessary precautions are taken to guarantee the safety of the operator and any other persons who may be affected.

Wear non-slip footwear when scrubbing. Use a respiratory mask in dusty environments.

The machine, while charging, must be positioned so that the mains plug is easily accessible.

When cleaning, servicing or maintaining the machine, replacing parts or converting to another function the power source shall be switched off.

Mains operated machines shall be disconnected by removing the power plug, and battery operated machines shall be disconnected by removing the isolating pin.

In order to prevent unauthorised use of the machine the power key must be removed after use.

Machines left unattended shall be secured against unintentional movement.

Operators shall be adequately instructed as to the correct use of the machine.

NOISE AND VIBRATION

Sound Level in use (L) < 78 dB(A)

The operators arms are subject to a vibration level of <2.5m/s when using the Machine.

NOTE:

In some applications, noise or vibration levels may exceed the figures stated. If

Noise levels exceed 85dB(A) appropriate ear protection must be used.

PRECAUTIONS WHEN WORKING WITH BATTERIES

1. Always wear protective clothing e.g. face visor, gloves and overalls when working with batteries
2. Whenever possible always use a properly designated and well-ventilated area for charging. Do not smoke or bring naked flames into the charging area.
3. Remove any metallic items from hands, wrists and neck i.e. rings, chains etc. before working on a battery.
4. Never rest tools or metallic objects on top of the battery.
5. When charging is complete disconnect from the mains supply.
6. The batteries must be removed from the machine before it is scrapped.
7. The machine must be disconnected from the supply when removing the battery.
8. To remove the batteries:- Disconnect machine from the mains supply (if charging) and ensure batteries are switched off with circuit disconnect switch (see page 7). Disconnect hoses from separator and tanks. Remove separator and tanks . Unscrew battery strap fixings and remove. Undo battery terminals and remove. Remove batteries.
9. The batteries are to be disposed of safely and in accordance with the battery directive.
10. Only use genuine NUMATIC replacement batteries.
11. Do not allow the batteries to become fully discharged; it may not be possible to recharge them. Batteries should not be discharged below 9.5 volts with 10 amps flowing.
12. Do not allow one battery to be discharged separately to the other.
13. Do not mix batteries from different machines.
14. The batteries fitted to this product are Valve Regulated Lead Acid (VRLA) gel electrolyte type. The fitting of any other type of battery may cause a safety hazard.

BATTERY CARE

1. Always recharge the batteries after use. This can be done at any time –it is not necessary to wait until they are fully discharged; they do not develop a “memory”.
2. Leaving the charger to operate for a minimum of 4 hours after the green light has come on, at least weekly, will prolong battery life.
3. Do not store the machine with the batteries discharged.

Note:

This appliance is not intended for use by persons (including children) with reduced physical sensory or mental capabilities, or lack of experience and knowledge.

Unless they have been given supervision or instruction concerning the use of the appliance by a person responsible for their safety.



Angaben zum Gerät

Produktplakette

Numatic
International Ltd
CHARD, ENGLAND, TA20 2GB

TTB XXXXX — Name und Adresse Unternehmen

BATTERY 24V -
CHARGING SUPPLY — Gerätebeschreibung
220-240v~ 400w 50Hz
OUTPUT 10 AMPS -

2% **XXX Kg** — Neigung (Nutz-) Gewicht
— CE-Kennzeichnung

— WEEE - Logo

DISCONNECT THE SUPPLY
BEFORE MAKING OR
BREAKING CONNECTIONS
TO THE BATTERY

— Gerät Jahr/Woche/Seriennummer
100621036

TTB XXXXS — Gerätebeschreibung

WEIGHT XXX Kg MAX — (Nutz-) Gewicht

NOISE WITH VAC xx dB(A) — Geräuschpegell

HAV xx m/s² — Hand-/Arm Vibration

WEEE-Richtlinie

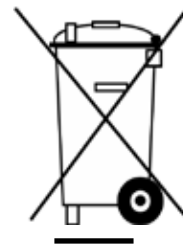

Staubsauger, Zubehör und Verpackung müssen getrennt entsorgt werden, um ein umweltfreundliches Recycling zu ermöglichen.

Für EU-Länder gilt:

Entsorgen Sie Staubsauger nicht im Hausmüll!
- gemäß EU-Richtlinie 2002/96/EC über die Entsorgung von Elektro- und Elektronikgeräten sowie deren Umsetzung in nationales Recht.
Staubsauger, die nicht mehr verwendet werden können, sind getrennt zu sammeln und zur umweltfreundlichen Entsorgung abzugeben.
In Deutschland sind das i.d.R. Sammelstellen beim örtlichen Entsorger.

Sicherheitsrelevante Bestandteile

Stromversorgung: H05VV-F x 1.5mm² x 3 core

PSA

(Persönliche Schutzausrüstung) kann für bestimmte Verwendung des Geräts erforderlich sein.

Ohrschutz	Sicherheitsschuhe	Kopfschutz	Sicherheitshandschuhe	Staub / Allergieschutz	Augenschutz	Schutzkleidung



Hinweisschild „Achtung Rutschgefahr“

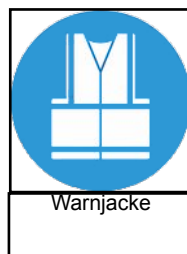

Warnjacke

Hinweis:

Eine Risikoauswertung ist vom Betreiber des Gerätes anhand der örtlichen Gegebenheiten vorzunehmen, um die erforderliche Schutzausrüstung festzulegen.

Baugruppe	Zeitabstand	Überprüfen auf
Netzleitung	täglich	Verschleiß, Risse, abgeschliffene Isolationsstellen
Bürsten	täglich	Borstenverschleiß, Fremdkörper, Verschleiß an der Kupplung
Sauglippen	vor jeder Benutzung	Abnutzung, Risse und sonstige Fehler
Filter	vor jeder Benutzung	Fremdkörper und Schmutz entfernen
Tanks	nach jeder Benutzung	nach Gebrauch Schmutzwassertank leeren und spülen



TTB 3450 / 100S

Borstelmotoren	Zuigermotor	Vermogen	Schalldruckpegel	Drehzahl	Bürste	Pad
400W	400W	Gell Akku 24V (2 X 12 V) = 100A/Hr	73 dB(A)	120rpm	450mm	400mm
Bruttogewicht (voll)	Schutzklasse	Trillingen handen/armen	Abmessungen	Nettogewicht	Wasserkapazität	
152Kg	Class 1	0.4 +/- 0.05ms ²	1150x930x790	122 Kg	30 L	



TTB4552 / 100S

Borstelmotoren	Zuigermotor	Vermogen	Schalldruckpegel	Drehzahl	Bürste	Pad
2 x 400W	400W	Gell Akku 24V (2 X 12 V) = 100A/Hr	70 dB(A)	120rpm	2 x 280mm	2 x 280mm
Bruttogewicht (voll)	Schutzklasse	Trillingen handen/armen	Abmessungen	Nettogewicht	Wasserkapazität	
166Kg	Class 1	0.7 +/- 0.05ms ²	1150x930x850	126 Kg	40 L	



TTB 4500 / 100S

Borstelmotoren	Zuigermotor	Vermogen	Schalldruckpegel	Drehzahl	Bürste	Pad
400W	400W	Gel Akku 24V (2 X 12 V) = 100A/Hr	74 dB(A)	120rpm	500mm	450mm
Bruttogewicht (voll)	Schutzklasse	Trillingen handen/armen	Abmessungen	Nettogewicht	Wasserkapazität	
154Kg	Class 1	0.5 +/- 0.05ms ²	1150x960x850	124 Kg	40 L	



ORIGINALANLEITUNG
VOR GEBRAUCH AUFMERKSAM UND VOLLSTÄNDIG LESEN

Informationen für Schrobzuigmachine

Maßnahmen:-

VORSICHT:

Lesen Sie das Handbuch gründlich durch, bevor Sie das Gerät einsetzen.

Dieses Produkt erfüllt die Anforderungen gemäß BS. EN 60335-2-72

WARNHINWEIS:

Wie bei allen elektrischen Geräten ist während der Benutzung jederzeit Vorsicht und Aufmerksamkeit geboten. Darüber hinaus muss zur Gewährleistung eines sicheren Betriebs in regelmäßigen Abständen eine laufende und vorbeugende Wartung durchgeführt werden.

Wenn Sie die Wartung nicht im nötigen Umfang durchführen, darin eingeschlossen das Verwenden von korrekten Ersatzteilen, kann die Sicherheit dieser Maschine beeinträchtigt werden, und der Hersteller kann weder die Verantwortung noch eine Haftung in dieser Hinsicht übernehmen.

Nennen Sie bei der Bestellung von Ersatzteilen immer die Modell- oder Seriennummer, die auf dem Leistungsschild angegeben ist.

Warnhinweis: Verwenden Sie das Gerät nicht auf geneigten Oberflächen.

ANMERKUNG:

Dieses Gerät ist zusätzlich zu seiner Verwendbarkeit in privaten Haushalten auch für den gewerblichen Einsatz geeignet, beispielsweise in Hotels, Schulen, Krankenhäusern, Fabriken, Läden und Büros.

VORSICHT:

Dieses Gerät ist nicht für die Aufnahme von gefährlichem Staub geeignet.

Verwenden Sie das Gerät nicht auf Oberflächen, die stärker geneigt sind, als auf dem Gerät gekennzeichnet ist.

Das Gerät darf nicht in Außenbereichen oder unter feuchten Bedingungen abgestellt werden.

Dieses Gerät ist nur für den Einsatz im Innenbereich ausgelegt.

Worauf zu achten ist:

Stellen Sie sicher, dass nur entsprechend befähigte Personen das Gerät auspacken/zusammenbauen.

Halten Sie das Gerät sauber.

Halten Sie die Bürsten in einem guten Zustand.

Ersetzen Sie abgenutzte oder beschädigte Teile unverzüglich.

Überprüfen Sie das Netzkabel regelmäßig auf Beschädigungen, wie z. B. Risse oder Abnutzungserscheinungen.

Wenn Sie feststellen, dass das Kabel beschädigt ist, ersetzen Sie es, bevor Sie weiterarbeiten.

Ersetzen Sie das Netzkabel nur durch das korrekte, von Numatic bestätigte Ersatzteil.

Stellen Sie sicher, dass sich keine Hindernisse oder Personen im Arbeitsbereich befinden.

Achten Sie darauf, dass der Arbeitsbereich gut beleuchtet ist.

Wischen Sie den zu reinigenden Bereich vor.

Verwenden Sie KEINE Dampf- oder Druckreiniger zum Reinigen des Geräts, und verwenden Sie das Gerät NICHT im Regen.

Führen Sie KEINE Wartungs- oder Reinigungsarbeiten am Gerät durch, wenn der Netzstecker noch in der Steckdose steckt.

Lassen Sie Reparaturarbeiten NICHT von unerfahrenen Personen durchführen. Wenden Sie sich dazu an qualifizierte Fachleute.

Belasten Sie NICHT das Kabel, und ziehen Sie NICHT daran, um den Stecker von der Stromversorgung zu trennen.

Nehmen Sie die Bürste bzw. das Pad ab, wenn Sie das Gerät nicht verwenden.

Das Gerät darf NICHT von unerfahrenen, nicht berechtigten bzw. nicht entsprechend geschulten Personen bedient werden.

Verwenden Sie das Gerät NICHT, wenn die Lösungstanks nicht ordnungsgemäß (so wie in der Anleitung gezeigt) am Gerät angebracht sind.

Gehen Sie davon aus, dass das Gerät NUR dann störungsfrei und zuverlässig betrieben werden kann, wenn es ordentlich gewartet wird.

Fahren Sie mit dem Gerät im Einsatz NICHT über Strom führende Kabel.

Heben oder ziehen Sie das Gerät nicht an Betriebsschaltern. Verwenden Sie dazu den Hauptgriff.

Bauen Sie den Griff NUR zur Wartung oder Reparatur vom Gerät ab.

Warnhinweis:

Verwenden Sie nur die Bürsten, die zusammen mit dem Gerät geliefert wurden bzw. die im Handbuch angegeben sind.

Durch die Verwendung anderer Bürsten kann die Sicherheit beeinträchtigt werden.

Für dieses Produkt ist ein umfassender Satz an Bürsten und weiteren Zubehörteilen erhältlich. Verwenden Sie nur Bürsten oder Pads, die für den korrekten Betrieb des Geräts bei der speziellen durchzuführenden Aufgabe geeignet sind.

Achten Maschine ausgeschaltet ist, wenn nicht in Gebrauch

Warnhinweis:

Es ist entscheidend, dass dieses Gerät richtig zusammengebaut und entsprechend den aktuell geltenden Sicherheitsvorschriften bedient wird.

Stellen Sie bei Verwendung des Geräts stets sicher, dass alle notwendigen Sicherheitsvorkehrungen umgesetzt wurden, um die Sicherheit des Bedieners sowie anderer, möglicherweise betroffener Personen zu gewährleisten. Tragen Sie beim Scheuern rutschfestes Schuhwerk. Verwenden Sie in staubigen Umgebungen eine Atemschutzmaske.

Das Gerät muss beim Laden so aufgestellt werden, dass der Netzstecker leicht zugänglich ist.

Wenn das Gerät gereinigt, gewartet oder anderweitig gepflegt wird, wenn Teile ausgetauscht werden oder wenn das Gerät in einen anderen Verwendungsmodus umgeschaltet wird, muss die Stromversorgung getrennt werden.

Bei mit Netzstrom betriebenen Geräten muss dazu der Netzstecker gezogen werden, während bei batteriebetriebenen Geräten der Isolierstift entfernt werden muss.

Um eine nicht autorisierte Verwendung des Geräts zu verhindern, muss der Zündschlüssel nach jedem Einsatz abgezogen werden.

Wenn das Gerät unbeaufsichtigt gelassen wird, sollte es gegen unbeabsichtigte Bewegung gesichert werden.

Die Bediener müssen entsprechend in die richtige Verwendung des Geräts eingewiesen werden.

GERÄUSCHE UND VIBRATIONEN

Schallpegel im Einsatz (L) < 78 dB(A)

Die Arme des Bedieners sind beim Einsatz des Geräts Vibrationen von < 2,5 m/s ausgesetzt.

ANMERKUNG:

In einigen Anwendungen können der Geräuschpegel oder die Vibrationen die hier angegebenen Werte überschreiten. Wenn der Geräuschpegel über 85 dB(A) liegt, muss ein entsprechender Gehörschutz getragen werden.

VORSICHTSMASSNAHMEN BEIM ARBEITEN MIT BATTERIEN

1. Tragen Sie beim Arbeiten mit Batterien stets eine entsprechende Schutzausrüstung, z. B. Gesichtsschutz, Handschuhe und angemessene Arbeitskleidung.
2. Wann immer es möglich ist, sollte das Laden in einem speziell ausgewiesenen, gut belüfteten Bereich durchgeführt werden. Rauchen und der Umgang mit offenem Feuer sind im Ladebereich untersagt.
3. Entfernen Sie alle Metallteile von Händen, Handgelenken und vom Hals (z. B. Ringe, Ketten usw.), bevor Sie an einer Batterie arbeiten.
4. Lassen Sie niemals Werkzeuge oder Metallobjekte oben auf der Batterie liegen.
5. Sobald der Ladevorgang abgeschlossen ist, trennen Sie das Gerät vom Netz.
6. Bevor ein Gerät ausrangiert wird, müssen die Batterien daraus entfernt werden.
7. Beim Herausnehmen der Batterie muss das Gerät vom Netz getrennt sein.
8. So entfernen Sie die Batterien: - Trennen Sie das Gerät von der Stromversorgung (wenn es gerade lädt), und stellen Sie sicher, dass die Batterien mit dem Trennschalter ausgeschaltet werden (siehe Seite 7). Trennen Sie die Schläuche vom Separator und von den Tanks.
Entfernen Sie den Separator und die Tanks. Schrauben Sie die Fixierungen für den Batterieriemen ab, und entfernen Sie diese.
9. Lösen Sie die Batterieanschlüsse, und entfernen Sie sie. Nehmen Sie die Batterien heraus.
10. Die Batterien müssen sicher und in Übereinstimmung mit den geltenden Richtlinien entsorgt werden.
11. Verwenden Sie nur Original-Ersatzbatterien von NUMATIC.
12. Achten Sie darauf, dass die Batterien nicht vollständig entladen werden, da es sonst möglich ist, dass sie nicht wieder aufgeladen werden können. Batterien sollten nicht unter eine Spannung von 9,5 Volt bei einer Stromstärke von 10 A entladen werden.
13. Achten Sie darauf, dass die Batterien nicht ungleichmäßig (d. h. voneinander getrennt) entladen werden.
14. Mischen Sie nicht Batterien von unterschiedlichen Geräten.
15. Die in diesem Produkt eingesetzten Batterien sind verschlossene Bleiakkumulatoren (VRLA, Valve Regulated Lead Acid) mit Gel-Elektrolyt. Die Verwendung anderer Batterietypen kann ein Sicherheitsrisiko darstellen.

BATTERIEPFLEGE

1. Laden Sie die Batterien nach jedem Einsatz wieder auf. Dies kann jederzeit erfolgen – Sie müssen nicht warten, bis die Batterien vollständig entladen sind, da es hier keinen „Memory-Effekt“ gibt.
2. Wenn das Ladegerät mindestens einmal wöchentlich nach dem Aufleuchten der grünen Leuchte für mindestens weitere 4 Stunden angeschlossen bleibt, lässt sich die Betriebslebensdauer der Batterie verlängern.
3. Stellen Sie die Maschine nicht mit entladenen Batterien ab.

Anmerkung:

Diese Maschine darf nicht von Kindern oder Personen mit eingeschränkten physisch-motorischen oder geistigen Fähigkeiten oder von Personen mit mangelnder Erfahrung und Kenntnis bedient werden.

Letztere dürfen die Maschine nur unter Aufsicht oder nach spezieller Unterweisung in der Verwendung der Maschine durch eine für die Sicherheit verantwortliche Person bedienen.



Sur la machine

Plaque signalétique

Numatic International Ltd — Nom et adresse du fabricant
 CHARD, ENGLAND, TA20 2GB

TTB XXXXX — Description machine

BATTERY 24V - CHARGING SUPPLY 220-240v~ 400w 50Hz OUTPUT 10 AMPS - Tension/Fréquence

2% XXX Kg — Pente
 — Poids brut
 — Norme CE

CE, IPX4 — Logo-DEEE

DISCONNECT THE SUPPLY BEFORE MAKING OR BREAKING CONNECTIONS TO THE BATTERY

100621036 — Année/Semaine/Numéro de série de la machine

Législation WEEE (DEEE)

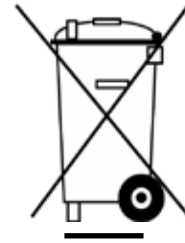

Les aspirateurs, accessoires et emballages répondent aux critères de recyclage et d'environnement.

Pour CEE seulement :

Ne pas jeter l'aspirateur comme déchet ménager.

En accord avec la directive 2002/96/EC du 27 janvier 2003

sur les déchets électriques et électroniques

(Directive WEEE pour Waste Electrical and Electronic Equipment)

et ses applications au niveau national, les aspirateurs en fin de vie

doivent être collectés et récupérés par un organisme compétent

en matière de gestion environnementale des déchets.

TTB XXXXS — Description machine

WEIGHT XXX Kg MAX — Poids brut

NOISE WITH VAC xx dB(A) — Niveau de bruit

HAV xx m/s² — Vibrations main-bras

Composants de sécurité critiques :

Câble d'alimentation: H05VV-F x 1.5mm² x 3 core

EPI

(Équipement de Protection Individuel) Recommandés pour certaines applications :

Protections sonores	Chaussures de sécurité	Casque de protection	Gants de protection	Protection contre poussières / allergènes	Lunettes de protection	Vêtements de sécurité



Panneau de signalisation au sol



Note :

Une évaluation des risques devra être menée pour définir les obligations d'utilisation des EPI.

Éléments	Fréquence	À vérifier
Câble d'alimentation	Journalier	Éraflures, fissures, coupures, fils dénudés
Brosses	Journalier	Usure des soies, usure du pas de fixation
Lamelles	Avant chaque utilisation	Usure, fissures, coupures
Filtres	Avant chaque utilisation	Colmatage et encrassement par des déchets
Réservoirs	Après chaque utilisation	Rincez le réservoir sale après utilisation



TTB 3450 / 100S

Moteurs de brosse	Moteur Vac	Puissance	Niveau sonore	Vitesse	Broose	Pad
400W	400W	Batterie au Gel 24V (2 X 12 V) = 100A/Hr	73 dB(A)	120rpm	450mm	400mm
Poids total machine remplie	Classe de protection	Vibrations main-bras	Dimensions	Poids net	Capacité en eau	
152Kg	Class 1	0.4 +/- 0.05ms ²	1150x930x790	122 Kg	30 L	



TTB4552 / 100S

Moteurs de brosse	Moteur Vac	Puissance	Niveau sonore	Vitesse	Broose	Pad
2 x 400W	400W	Batterie au Gel 24V (2 X 12 V) = 100A/Hr	70 dB(A)	120rpm	2 x 280mm	2 x 280mm
Poids total machine remplie	Classe de protection	Vibrations main-bras	Dimensions	Poids net	Capacité en eau	
166Kg	Class 1	0.7+/- 0.05ms ²	1150x930x850	126 Kg	40 L	



TTB 4500 / 100S

Moteurs de brosse	Moteur Vac	Puissance	Niveau sonore	Vitesse	Broose	Pad
400W	400W	Batterie au Gel 24V (2 X 12 V) = 100A/Hr	74 dB(A)	120rpm	500mm	450mm
Poids total machine remplie	Classe de protection	Vibrations main-bras	Dimensions	Poids net	Capacité en eau	
154 Kg	Class 1	0.5 +/- 0.05ms ²	1150x960x850	124 Kg	40 L	



**Veillez lire le manuel d'instruction avant d'utiliser l'appareil.
Les utilisateurs doivent être correctement formés à l'utilisation de ces appareils.**

Aspirateurs Poussières

Moyens :-

MISE EN GARDE :

Lisez le mode d'emploi avant d'utiliser l'appareil.

Ce produit est conforme aux exigences de la norme BS EN 60335-2-72.

ATTENTION :

Comme pour tout équipement électrique, il convient d'être prudent et vigilant à tout instant lorsqu'on l'utilise, en plus de s'assurer que son entretien courant et préventif est bien effectué régulièrement pour qu'il reste en bon état de fonctionnement.

Si l'entretien nécessaire n'est pas effectué et si l'on ne remplace pas les pièces à changer par des pièces à la bonne norme, l'équipement pourrait devenir dangereux et le fabricant ne pourra accepter aucune responsabilité à cet égard. Lorsque vous commandez des pièces de rechange, indiquez toujours le numéro du modèle / numéro de série indiqué sur la plaque signalétique.

Attention à ne pas utiliser la machine sur des sols en pente.

REMARQUE :

Cette machine est également adaptée à un usage commercial, par exemple pour les hôtels, les écoles, les hôpitaux, les usines, les magasins et les bureaux à des fins autres que les besoins ménagers normaux.

MISE EN GARDE :

Cette machine n'est pas conçue pour le ramassage de poussières dangereuses.

Ne pas utiliser sur des surfaces ayant une pente supérieure à celle indiquée sur l'appareil.

La machine ne doit pas être rangée à l'extérieur dans un environnement humide.

Cette machine est réservée à un usage intérieur.

Choses à faire et à ne pas faire :

Veillez à ce que seules des personnes compétentes déballent/assemblent la machine.

Maintenez votre machine propre.

Maintenez vos brosses en bon état.

Remplacez immédiatement toute pièce usée ou endommagée.

Examinez régulièrement le câble d'alimentation pour voir s'il comporte des traces d'endommagement telles que des fissures ou un vieillissement. S'il est endommagé, remplacez-le avant toute nouvelle utilisation.

Ne remplacez le câble d'alimentation que par la pièce de rechange correcte approuvée par Numatic.

Assurez-vous que la zone de travail n'est pas encombrée et que personne ne passe par là.

Assurez-vous que la zone de travail est bien éclairée.

Balayez au préalable la zone à nettoyer.

N'utilisez pas de nettoyeurs à vapeur ou de nettoyeurs haute pression pour nettoyer la machine et évitez toute utilisation sous la pluie.

Ne procédez pas à l'entretien ou au nettoyage de la machine si celle-ci est branchée dans la prise de courant.

Ne laissez pas une personne inexpérimentée effectuer des réparations. Faites appel à une personne compétente.

N'exercez pas de traction excessive sur le câble, et ne débranchez jamais le câble en tirant dessus.

Ne laissez pas de brosse rotative sur la machine lorsque celle-ci n'est pas utilisée.

Ne laissez pas des opérateurs inexpérimentés, non autorisés ou sans formation appropriée utiliser la machine.

N'utilisez pas la machine si les réservoirs de solution n'ont pas été installés correctement, comme indiqué dans le mode d'emploi.

Ne négligez pas l'entretien de la machine si vous souhaitez qu'elle fonctionne de manière fiable et sans problème.

Ne faites pas rouler la machine sur des câbles électriques pendant l'utilisation.

Ne soulevez ni ne tirez jamais la machine par ses commandes. Utilisez la poignée principale.

Ne retirez jamais la poignée de la machine, sauf pour l'entretien ou les réparations.

Attention :

Utilisez uniquement les brosses fournies avec l'appareil ou celles spécifiées dans le mode d'emploi.

Utiliser des brosses d'un autre type peut nuire à la sécurité.

Une gamme complète de brosses et d'accessoires est disponible pour ce produit.

N'utilisez que des brosses ou des disques qui sont appropriés pour le bon fonctionnement de la machine pour la tâche particulière à effectuer.

Lorsqu'elle n'est pas utilisée, la machine doit être éteinte en position OFF

Attention :

Il est essentiel que cet équipement soit monté correctement et utilisé conformément aux normes de sécurité en vigueur.

Lors de l'utilisation de l'équipement, veillez à ce que toutes les précautions nécessaires soient prises systématiquement pour garantir la sécurité de l'opérateur et de toute autre personne qui pourrait se trouver aux alentours.

Portez des chaussures antidérapantes lors du récurage. Portez un masque respiratoire dans les environnements poussiéreux.

La machine, pendant la charge, doit être positionnée de sorte que la fiche secteur soit facilement accessible.

Pendant le nettoyage, la réparation ou l'entretien de la machine, le remplacement de pièces ou la conversion pour changer de fonction, la source d'alimentation doit être coupée.

Pour les machines alimentées par le secteur, le câble d'alimentation doit être débranché de la prise de courant. Pour les machines alimentées par batterie, effectuez le débranchement en retirant la broche d'isolation.

Pour éviter toute utilisation non autorisée de la machine, retirez la clé d'alimentation après usage.

Les machines laissées sans surveillance doivent être protégées contre tout déplacement involontaire.

Les opérateurs doivent recevoir toutes les instructions nécessaires pour utiliser correctement la machine.

BRUIT ET VIBRATIONS

Niveau sonore pendant l'utilisation (L) < 78 dB(A)

Les bras des opérateurs sont soumis à un niveau de vibration < 2,5 m/s lors de l'utilisation de la machine.

REMARQUE :

Dans certains cas d'utilisation, les niveaux de bruit ou de vibration peuvent dépasser les valeurs indiquées. Si le niveau de bruit dépasse 85dB(A), il convient de porter des protections auditives appropriées.

PRÉCAUTIONS À PRENDRE EN TRAVAILLANT AVEC LES BATTERIES

1. Portez toujours des vêtements de protection, par exemple visière, gants et combinaison, lorsque vous travaillez avec des batteries.
2. Dans la mesure du possible, utilisez toujours une zone bien aménagée et bien aérée pour procéder à la charge. Ne pas fumer ni approcher de flammes nues dans la zone de charge.
3. Retirez tous les objets métalliques des mains, des poignets et du cou, à savoir les bagues, les chaînes, etc. avant d'intervenir sur une batterie.
4. Ne déposez jamais d'outils ou d'objets métalliques sur le dessus de la batterie.
5. Lorsque la charge est complète, débranchez le câble d'alimentation.
6. Les batteries doivent être retirées de la machine avant que celle-ci ne soit mise au rebut.
7. La machine doit être débranchée de la prise lorsque vous retirez la batterie.
8. Pour retirer les batteries : débranchez la machine du secteur (si elle est en charge) et vérifiez que les batteries ont bien été coupées avec le commutateur coupe-circuit (voir page 7). Débranchez les tuyaux du séparateur et des réservoirs.
- Retirez le séparateur et les réservoirs. Dévissez les fixations de sangle de batterie et retirez-les.
- Défaites les bornes des batteries et retirez-les. Retirez les batteries.
9. Les batteries doivent être éliminées avec précaution et dans le respect de la réglementation les concernant.
10. N'utilisez que des batteries de rechange authentiques NUMATIC.
11. Ne laissez pas les batteries se décharger complètement, car il pourrait être impossible de les recharger par la suite. Les batteries ne doivent pas être déchargées en dessous de 9,5 volts avec un débit de 10 ampères.
12. Ne laissez pas une batterie se décharger séparément de l'autre.
13. Ne mélangez pas les batteries de différentes machines.
14. Les batteries utilisées avec ce produit sont du type au gel électrolyte au plomb-acide à régulation par valve (VRLA). L'installation de tout autre type de batterie peut entraîner un danger pour la sécurité.

ENTRETIEN DES BATTERIES

1. Rechargez toujours les batteries après usage. Vous pouvez le faire à tout moment – il n'est pas nécessaire d'attendre qu'elles soient entièrement déchargées ; elles ne développent pas de « mémoire ».
2. Le fait de laisser le chargeur fonctionner pendant un minimum de 4 heures après que la lumière verte s'est allumée, au moins une fois par semaine, permettra de prolonger la vie de la batterie.
3. N'entreposez pas la machine avec les batteries déchargées.

Remarque :

Cet appareil n'est pas destiné à être utilisé par des personnes (y compris des enfants) avec des capacités physiques, sensorielles ou mentales réduites, ou manquant d'expérience et de connaissances, sauf si elles ont reçu des consignes ou des instructions quant à l'utilisation de l'appareil par une personne responsable de leur sécurité.



Over de machine

Type Plaatje

Numatic
International Ltd — Fabrikant
CHARD, ENGLAND, TA20 2GB

TTB XXXXX — Machine omschrijving

BATTERY 24V -
CHARGING SUPPLY — Voltage / frequentie
220-240v~ 400w 50Hz
OUTPUT 10 AMPS -

2% **XXX Kg** — Hellingshoek
— Gewicht
— CE keurmerk

— WEEE Logo

DISCONNECT THE SUPPLY
BEFORE MAKING OR
BREAKING CONNECTIONS
TO THE BATTERY

— Jaar-week-serienummer
100621036

TTB XXXXS — Machine omschrijving

WEIGHT XXX Kg MAX — Gewicht

NOISE — Geluidsniveau
WITH VAC xx dB(A)

HAV xx m/s² — Trillingen handen/armen

WEEE wetgeving



De stofzuiger, accessoires en verpakking dienen gesorterd te worden teneinde alle onderdelen milieuvriendelijk te weggooien

Geldt alleen voor EU landen

U mag de stofzuiger, volgens de Europese Richtlijn 2002/96/EN met betrekking tot het weggooien van elektronische apparatuur en zoals opgenomen in de Nederlandse wetgeving, niet met het huishoudelijk afval weggooien.

Stofzuigers die niet langer geschikt zijn voor gebruik moeten apart worden ingeleverd, zodat ze op een milieuvriendelijke manier kunnen worden verwerkt.

Veiligheidsgevoelige componenten

Aansluitsnoer: H05VV-F x 1.5mm² x 3 core

PERSOONLIJKE BESCHERMING

die vereist kan zijn bij het uitvoeren van bepaalde werkzaamheden

Gehörschutz	Veiligheidsschoeisel	Veiligheidshelm	Veiligheidshand- schoenen	Adembescherming	Oogbescherming	Beschermende kleding



Waarschuwbord



Anmerkung:

Eine Risikobeurteilung sollte durchgeführt werden, um zu entscheiden, welche PSA zu tragen ist.

Component	Interval	Inspectie
Snoer	Dagelijks	slijtage, breuk, beschadigingen
Borstels	Dagelijks	Beschadigingen, slijtage
Rubbers Zuigmond	Voor ieder gebruik	Slijtage, beschadigingen
Filters	Voor ieder gebruik	Verstopingen en restanten vuil
Tanks	Voor ieder gebruik	Verwijderen van vuilwater, doorspoelen



TTB 3450 / 100S

BORSTELMOTOREN	ZUIGERMOTOR	VERMOGEN	GELUIDSDRUK	SNELHEID	BORSTEL	PAD
400W	400W	GELL - ACCU 24V (2 X 12 V) = 100A/Hr	73 DB(A)	120RPM	450MM	400MM
BRUTOGEWICHT VOL	KLASSE	TRILLINGEN HANDEN/ ARMEN	AFMETINGEN	NETTOGEWICHT	INHOUD WATER- TANK	
152Kg	Class 1	0.4 +/- 0.05ms ²	1150x930x790	122 Kg	30 L	



TTB4552 / 100S

BORSTELMOTOREN	ZUIGERMOTOR	VERMOGEN	GELUIDSDRUK	SNELHEID	BORSTEL	PAD
2 x 400W	400W	GELL - ACCU 24V (2 X 12 V) = 100A/Hr	70 DB(A)	120RPM	2 x 280MM	2 x 280MM
BRUTOGEWICHT VOL	KLASSE	TRILLINGEN HANDEN/ ARMEN	AFMETINGEN	NETTOGEWICHT	INHOUD WATER- TANK	
166Kg	Class 1	0.7 +/- 0.05ms ²	1150x930x850	126 Kg	40 L	



TTB 4500 / 100S

BORSTELMOTOREN	ZUIGERMOTOR	VERMOGEN	GELUIDSDRUK	SNELHEID	BORSTEL	PAD
400W	400W	GELL - ACCU 24V (2 X 12 V) = 100A/Hr	74 DB(A)	120RPM	500MM	450MM
BRUTOGEWICHT VOL	KLASSE	TRILLINGEN HANDEN/ ARMEN	AFMETINGEN	NETTOGEWICHT	INHOUD WATER- TANK	
154Kg	Class 1	0.5 +/- 0.05ms ²	1150x960x850	124 Kg	40 L	



Originele gebruiksaanwijzing
Lezen voor gebruik

Informatie over stofzuigers voor droog gebruik

Betekeningen:-

OPGELET:

Lees de gebruikershandleiding alvorens deze machine in gebruik te nemen.

Dit product voldoet aan de norm BS. EN 60335-2-72

WAARSCHUWING:

Zoals voor alle elektrische apparatuur dient tijdens gebruik steeds de nodige zorgvuldigheid in acht te worden genomen en moet regelmatig periodiek en preventief onderhoud worden uitgevoerd om de veiligheid van de machine te kunnen garanderen.

Het niet uitvoeren van het nodige onderhoud of het vervangen van onderdelen door inferieure onderdelen, kan de veiligheid in gevaar brengen. De fabrikant kan hiervoor in geen geval aansprakelijk worden gesteld.

Vermeld bij het bestellen van reserveonderdelen steeds het op het kenplaatje vermelde modelnummer/serienummer.

Niet geschikt voor gebruik op hellingen.

OPMERKING:

Deze machine is tevens geschikt voor zwaar gebruik, d.w.z. zwaarder dan huishoudelijk gebruik, zoals bijvoorbeeld in hotels, scholen, ziekenhuizen, fabrieken, winkels en kantoren.

OPGELET:

Deze machine mag niet worden gebruikt voor het opvegen van gevaarlijk stof.

Gebruik de machine niet op oppervlakken met een helling die de op de machine aangegeven maximale hellingshoek overschrijdt.

De machine mag niet buiten of in vochtige omgevingen worden opgeborgen.

Deze machine is uitsluitend voor gebruik binnen bestemd.

Wat WEL en wat NIET te doen:

WEL - zorg ervoor dat de machine alleen door ervaren personen worden uitgepakt/gemonteerd.

WEL - houd de machine schoon.

WEL - houd de borstels in goede staat.

WEL - vervang versleten of beschadigde onderdelen meteen.

WEL – controleer de stroomkabel regelmatig op beschadigingen, zoals scheurtjes of breuken. Vervang de kabel als deze beschadigd is, voordat u de machine opnieuw gaat gebruiken.

WEL - Vervang de stroomkabel uitsluitend door het betreffende en door Numatic goedgekeurde vervangende onderdeel.

WEL - zorg ervoor dat er zich geen obstakels en/of mensen in de werkzone bevinden.

WEL - zorg ervoor dat de werkzone goed verlicht is.

WEL - veeg de zone die u gaat schoonmaken vooraf schoon.

NIET - gebruik geen stoomreiniger of hogedrukspuit om de machine schoon te maken en gebruik de machine nooit in de regen.

NIET – Onderhoud of reinig het apparaat niet terwijl de stekker in het stopcontact steekt.

NIET - laat nooit reparaties door onbevoegden uitvoeren. Laat dat aan specialisten over.

NIET – zorg ervoor dat de kabel nooit strak wordt gespannen en haal de kabel nooit uit het stopcontact door eraan te trekken.

NIET - laat de borstelplaat niet aan de machine zitten wanneer deze niet in gebruik is.

NIET - de machine mag niet worden gebruikt door onervaren of onbevoegde bedieners die niet de nodige opleiding hebben gekregen.

NIET – gebruik de machine niet als de reinigingsmiddeltanks niet correct zijn aangebracht, zoals in de instructies aangegeven.

NIET - verwacht niet dat de machine probleemloos zal werken wanneer deze niet correct wordt onderhouden.

NIET – rijd tijdens bedrijf niet met de machine over de stroomkabel.

NIET – gebruik nooit de instelhendels om de machine te verplaatsen of op te tillen - gebruik hiervoor uitsluitend de stuurhendel.

NIET – verwijder de stuurhendel nooit van de machine, behalve voor onderhoud of reparatie.

WAARSCHUWING:

Gebruik enkel borstels die bij de machine worden geleverd of borstels die uitdrukkelijk in de gebruikershandleiding staan vermeld.

Het gebruik van andere borstels kan de veiligheid in gevaar brengen.

Er is voor deze machine een volledig gamma borstels en accessoires verkrijgbaar.

Gebruik enkel borstels of pads die een goede werking van de machine en een correcte uitvoering van de betreffende taak garanderen.

De machine moet uitgeschakeld zijn wanneer deze niet in gebruik is.

WAARSCHUWING:

Het is van het grootste belang dat deze machine correct wordt gemonteerd en bediend conform de geldende veiligheidsvoorschriften.

Let er bij het gebruiken van deze machine steeds op dat alle nodige voorzorgsmaatregelen worden genomen om de veiligheid van de bediener en mogelijke omstaanders te garanderen.

Draag bij het schrobben altijd schoenen met antislipzool. Draag in stoffige omgevingen altijd een stofmasker.

Plaats de machine bij het opladen altijd zo dat het stopcontact eenvoudig toegankelijk is.

Tijdens reiniging, onderhoud of reparatie van de machine, vervangen van onderdelen of het overschakelen naar een andere functie, dient de stroombron uitgeschakeld te zijn.

Bij de op het stroomnet werkende machines dient de stekker uit het stopcontact te worden getrokken en bij de op accu's werkende machines dient de isoleerpin te worden verwijderd.

Om onbevoegd gebruik van de machine te voorkomen, dient de contactsleutel na gebruik te worden verwijderd. Wanneer een machine onbeheerd wordt achtergelaten, dient deze te worden vastgezet zodat ze niet ongewild kan gaan bewegen.

Gebruikers dienen goed geïnstrueerd te worden met betrekking tot de juiste bediening van de machine.

GELUID EN TRILLINGEN

Geluidsniveau tijdens gebruik (L) < 78 dB(A)

Tijdens gebruik van de machine zullen de armen van gebruikers worden blootgesteld aan een trillingsniveau van <2,5m/s.

OPMERKING:

Bij sommige toepassingen kunnen de aangegeven geluids- en trillingsniveaus worden overschreden. Indien het geluidsniveau hoger is dan 85dB(A), dient geschikte oorbescherming te worden gedragen.

VOORZORGSMATREGELEN BIJ HET WERKEN MET ACCU'S

1. Draag steeds beschermende kledij zoals een gezichtsmasker, handschoenen en overall wanneer u werkt met accu's
2. Laad de accu's indien mogelijk steeds in een specifiek daartoe voorziene en goed geventileerde ruimte op. In dergelijke ruimtes mag niet gerookt worden en mogen geen toestellen met open vlam worden gebruikt.
3. Verwijder alle metalen voorwerpen zoals ringen, kettingen, enz. van handen, polsen en nek alvorens aan een accu te werken.
4. Laat nooit gereedschap of metalen voorwerpen bovenop een accu liggen.
5. Haal het laadsnoer uit het stopcontact zodra het opladen voltooid is.
6. De accu's moeten uit de machine worden gehaald wanneer die definitief buiten dienst wordt gesteld.
7. De machine mag niet aangesloten zijn op de netvoeding wanneer u de accu verwijderd.
8. Verwijderen van de accu's:- Haal de stekker uit het stopcontact (indien van toepassing) en schakel de batterijen met behulp van de stroomonderbreker uit (zie pag. 7). Maak alle slangen van de scheider en de tanks los. Verwijder de scheider en de tanks. Schroef de bevestigingen voor de accuhouder los en verwijder deze. Maak de accuklemmen los en verwijder ze. Verwijder de accu's.
9. De accu's dienen op een veilige manier te worden afgevoerd en in overeenstemming met de betreffende richtlijn.
10. Gebruik uitsluitend originele vervangende accu's van NUMATIC.
11. Laat de accu's nooit volledig ontladen. Mogelijk kunt u ze daarna niet meer opladen. Accu's mogen nooit worden ontladen tot lager dan 9,5 volt bij 10 amp.
12. Laat één accu nooit los van de andere ontladen.
13. Gebruik nooit accu's van verschillende machines samen.
14. De in deze machine gebruikte accu's zijn VRLA-accu's van het gel-type. Het installeren van andere types accu's kan de veiligheid in gevaar brengen.

ACCU-ONDERHOUD

1. Laad de accu's na elk gebruik op. Dit kan op ongeacht welk tijdstip plaatsvinden – er hoeft niet te worden gewacht tot ze volledig ontladen zijn; er is geen sprake van een "geheugeneffect".
2. De nuttige levensduur van de accu wordt verlengd wanneer u de lader ten minste eenmaal per week minstens 4 uur laat werken nadat het groene lichtje begint te branden.
3. Berg de machine niet op met lege accu's.

Opmerking:

Deze machine mag niet worden gebruikt door mensen (inclusief kinderen) met beperkte fysieke, sensorische of mentale capaciteiten, of met een gebrek aan ervaring en kennis.

Tenzij ze de nodige opleiding voor het gebruik van de machine hebben gekregen of onder toezicht staan van iemand die instaat voor hun veiligheid.





Spares - Ersatzteile - Pièces Détachées - Reserve Onderdelen

TTB 3450 / 100S

				
577252	Top Tank	Schmutzwassertank	Réservoir Supérieur	Vuilwatertank
577258	Bottom Tank	Frischwassertank	Réservoir Inférieur	Schoonwatertank
577251	Separator	Separator	Séparateur	Verdeler
229282	Filter Cap	Einlauffilter	Bouchon de remplissage	Vuldop
206265	Barrel Filter	Kerzenfilter	Filtre conique	Filter
207000	Basket Filter	Grobschmutzfilter	Panier filtrant	Filter
206697	Vac hose	Saugschlauch Saugmotor	Flexible d'aspiration	Slang
206698	Floor Tool Hose	Saugschlauch Abstreifer	Flexible coté suceur	Slang
303768	Dump Hose Top	Ablaufschlauch oben	Flexible de vidange supérieur	Slang
303641	Dump Hose Bottom	Ablaufschlauch unten	Flexible de vidange inférieur	Slang
606216	Floor Tool	Abstreifer	Capteur / Suceur	Zuigmond
206953	Detent Pin	Arretierstift	Goupille	Borgpennen
204080	Wheel	Rad grau, 160 mm Ø	Roue	Wiel
577296	Deck	Bürstendeck	Carter	Borstelhuis
577260	Handle	Handgriff	Poignée	Handel
577298	Vac Pod	Saugmotor	Moteur d'aspiration	Zuigmotor
220386	Charger Cable UK	Ladekabel	câble de charge	Laadsnoer (UK)
221079	Charger Cable Euro	Ladekabel (Schuko- stecker)	câble de charge	Laadsnoer (europées)
220622	Charger Cable Switzerland	Ladekabel Schweiz	câble de charge	Laadsnoer (CH)
230103	Fuse (Batteries)	Sicherung Batterie	fusible de batteries	Zekeringen
230104	Fuse (Brush Motor)	Sicherung Bürstmotor	fusible de moteur de brosses	Zekeringen
230104	Fuse (Vac Motor)	Sicherung Saugmotor	fusible de moteur d'aspiration	Zekeringen
221037	Fuse (Charger)	Sicherung Ladegerät	fusible de chargeur	Zekeringen
220681	Isolator Pin / Key	Abschalt- + Sicherungsknopf	Coupe circuit	Sleutel/zekering pin

Accessories - Zubehör - Accessoires - Accessoires

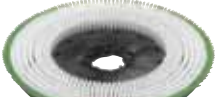
TTB 3450 / 100S

				
 606203	450mm Polyscrub Brush	450mm PPN Schrubbürste	450mm Brosse verte PPE	450mm PolyScrub Schrobborstel
 606204	450mm Nyloscrub Brush	450mm Nylon Schrubbürste	450mm Brosse douce Nylon	450mm Nyloscrub Shamponeerborstel
 606306	450mm Longlife Brush	450mm SC Schrubbürste Grün	450mm Brosse Verte Longlife	450mm Longlife Borstel
 606202	450mm Union Mix Brush	450mm Schrubbürste	450mm Brosse	450mm Borstel
 606206	400mm Pad Drive Board	400mm Nuloc Treibteller	400mm Plateau support Disque	400mm Nuloc aandrijfschijf
 606157	Optional Polyurethane Floor Tool Blade Set	Optional PU Ersatzgummilippen set (650mm) 2 Stück	Facultatif Lammelles pour suceur 650mm pour TTV	Optionele PU Vervangingset rubbers (2 stuks)
 606196	Recommended Linatex Floor tool Blade Set	Empfohlene Linatex Ersatzgummilippen set (650mm) 2 Stück	Recommandées Linatex Lammelles 650mm	Aanbevolen Linatex Vervangingset rubbers (2 stuks)



Spares - Ersatzteile - Pièces Détachées - Reserve Onderdelen

TTB 4552 \ 100S

				
577306	Top Tank	Schmutzwassertank	Réservoir Supérieur	Vuilwatertank
577307	Bottom Tank	Frischwassertank	Réservoir Inférieur	Schoonwatertank
577251	Separator	Separator	Séparateur	Verdeler
229282	Filter Cap	Einlauffilter	Bouchon de remplissage	Vuldop
206265	Barrel Filter	Kerzenfilter	Filtre conique	Filter
207000	Basket Filter	Grobschmutzfilter	Panier filtrant	Filter
206697	Vac hose	Saugschlauch Saugmotor	Flexible d'aspiration	Slang
206698	Floor Tool Hose	Saugschlauch Abstreifer	Flexible coté suceur	Slang
303768	Dump Hose Top	Ablaufschlauch oben	Flexible de vidange supérieur	Slang
303641	Dump Hose Bottom	Ablaufschlauch unten	Flexible de vidange inférieur	Slang
606216	Floor Tool	Abstreifer	Capteur / Suceur	Zuigmond
206953	Detent Pin	Arretierstift	Goupille	Borgpennen
204080	Wheel	Rad grau, 160 mm Ø	Roue	Wiel
577305	Deck	Bürstendeck	Carter	Borstelhuis
577260	Handle	Handgriff	Poignée	Handel
577298	Vac Pod	Saugmotor	Moteur d'aspiration	Zuigmotor
220386	Charger Cable UK	Ladekabel	câble de charge	Laadsnoer (UK)
221079	Charger Cable Euro	Ladekabel (Schukosteker)	câble de charge	Laadsnoer (europées)
220622	Charger Cable Switzerland	Ladekabel Schweiz	câble de charge	Laadsnoer (CH)
230103	Fuse (Batteries)	Sicherung Batterie	fusible de batteries	Zekeringen
230104	Fuse (Brush Motor)	Sicherung Bürstmotor	fusible de moteur de brosses	Zekeringen
230104	Fuse (Vac Motor)	Sicherung Saugmotor	fusible de moteur d'aspiration	Zekeringen
221037	Fuse (Charger)	Sicherung Ladegerät	fusible de chargeur	Zekeringen
220681	Isolator Pin / Key	Abschalt- + Sicherungsknopf	Coupe circuit	Sleutel/zekering pin

Accessories - Zubehör - Accessoires - Accessoires

TTB4552 / 100S

				
 606029	280mm Polyscrub Brush 2 X required	280mm PPN Schrubbürste 2 x Erforderliche	280mm Brosse verte PPE Requis 2 x	280mm PolyScrub Schrobborstel 2 x Vereist
 606552	280mm Nyloscrub Brush 2 X required	280mm Nylon Schrubbürste 2 x Erforderliche	280mm Brosse douce Nylon Requis 2 x	280mm Nyloscrub Shamponeerborstel 2 x Vereist
 606553	280mm Longlife Brush 2 X required	280mm SC Schrubbürste Grün 2 x Erforderliche	280mm Brosse Verte Longlife Requis 2 x	280mm Longlife Borstel 2 x Vereist
 606035	280mm Pad Drive Board 2 X required	280mm Nuloc Treibteller 2 x Erforderliche	280mm Plateau support Disque Requis 2 x	280mm Nuloc aandrijfschijf 2 x Vereist
 606157	Optional Polyurethane Floor Tool Blade Set	Optional PU Ersatzgummilippen set (650mm) 2 Stück	Facultatif Lammelles pour suceur 650mm pour TTV	Optionele PU Vervangingset rubbers (2 stuks)
 606196	Recommended Linatex Floor tool Blade Set	Empfohlene Linatex Ersatzgummilippen set (650mm) 2 Stück	Recommandées Linatex Lammelles 650mm	Aanbevolen Linatex Vervangingset rubbers (2 stuks)

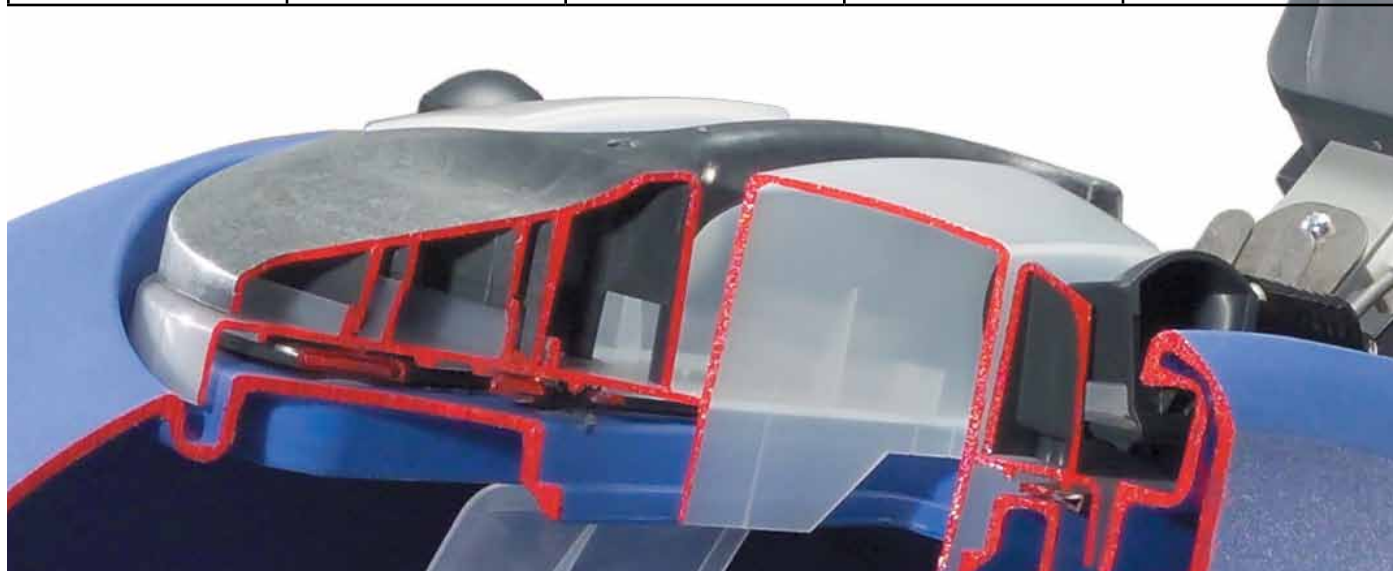

Spares - Ersatzteile - Pièces Détachées - Reserve Onderdelen

TTB 4500 / 100S

				
577306	Top Tank	Schmutzwassertank	Réservoir Supérieur	Vuilwatertank
577307	Bottom Tank	Frischwassertank	Réservoir Inférieur	Schoonwatertank
577251	Separator	Separator	Séparateur	Verdelers
229282	Filter Cap	Einlauffilter	Bouchon de remplissage	Vuldop
206265	Barrel Filter	Kerzenfilter	Filtre conique	Filter
207000	Basket Filter	Grobschmutzfilter	Panier filtrant	Filter
206696	Vac hose	Saugschlauch Saugmotor	Flexible d'aspiration	Slang
206698	Floor Tool Hose	Saugschlauch Abstreifer	Flexible coté suceur	Slang
303768	Dump Hose Top	Ablaufschlauch oben	Flexible de vidange supérieur	Slang
303641	Dump Hose Bottom	Ablaufschlauch unten	Flexible de vidange inférieur	Slang
577689	Floor Tool	Abstreifer	Capteur / Suceur	Zuigmond
206953	Detent Pin	Arretierstift	Goupille	Borgpennen
204080	Wheel	Rad grau, 160 mm Ø	Roue	Wiel
577363	Deck	Bürstendeck	Carter	Borstelhuis
577260	Handle	Handgriff	Poignée	Handel
577298	Vac Pod	Saugmotor	Moteur d'aspiration	Zuigmotor
220386	Charger Cable UK	Ladekabel	câble de charge	Laadsnoer (UK)
221079	Charger Cable Euro	Ladekabel (Schukosteker)	câble de charge	Laadsnoer (europées)
220622	Charger Cable Switzerland	Ladekabel Schweiz	câble de charge	Laadsnoer (CH)
230103	Fuse (Batteries)	Sicherung Batterie	fusible de batteries	Zekeringen
230104	Fuse (Brush Motor)	Sicherung Bürstmotor	fusible de moteur de brosses	Zekeringen
230104	Fuse (Vac Motor)	Sicherung Saugmotor	fusible de moteur d'aspiration	Zekeringen
221037	Fuse (Charger)	Sicherung Ladegerät	fusible de chargeur	Zekeringen
220681	Isolator Pin / Key	Abschalt- + Sicherungsknopf	Coupe circuit	Sleutel/zekering pin



Accessories - Zubehör - Accessoires - Accessoires

TTB4500 / 100S

				
 606028	550mm Polyscrub Brush	550mm PPN Schrubbürste	550mm Brosse verte PPE	550mm PolyScrub Schrobborstel
 606550	550mm Nyloscrub Brush	550mm Nylon Schrubbürste	550mm Brosse douce Nylon	550mm Nyloscrub Shamponeerborstel
 606551	550mm Longlife Brush	550mm SC Schrubbürste Grün	550mm Brosse Verte Longlife	550mm Longlife Borstel
 606702	550mm Union Mix Brush	550mm Schrubbürste	550mm Brosse	550mm Borstel
 606034	500mm Pad Drive Board	500mm Nuloc Treibteller	500mm Plateau support Disque	500mm Nuloc aandrijfschijf
 606157	Optional Polyurethane Floor Tool Blade Set	Optional PU Ersatzgummilippen set (650mm) 2 Stück	Facultatif Lammelles pour suceur 650mm pour TTV	Optionele PU Vervangingset rubbers (2 stuks)
 606196	Recommended Linatex Floor tool Blade Set	Empfohlene Linatex Ersatzgummilippen set (650mm) 2 Stück	Recommandées Linatex Lammelles 650mm	Aanbevolen Linatex Vervangingset rubbers (2 stuks)







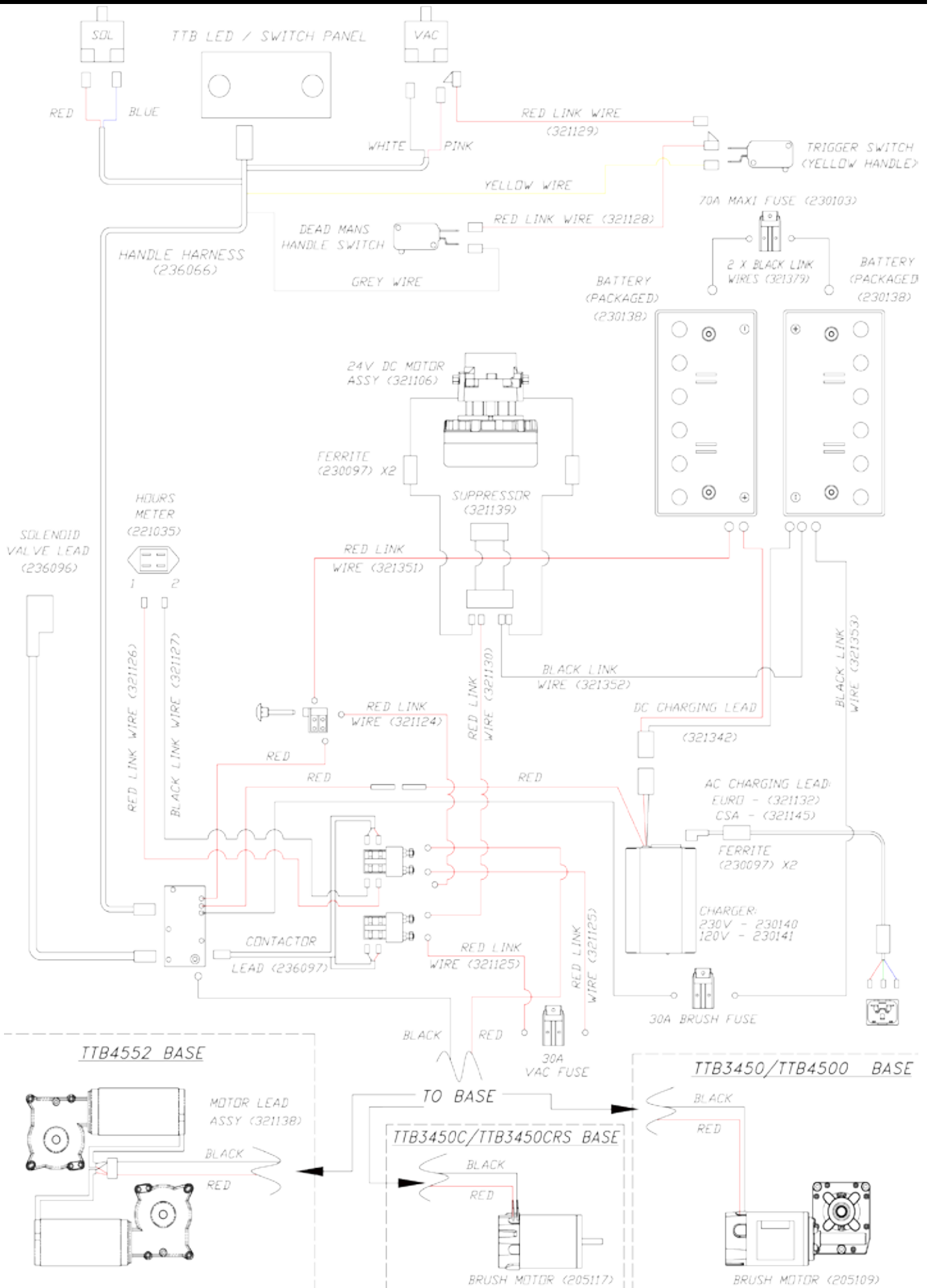















TTB3450 / 4500 / 4552 / 3450C / 3450CRS Wiring Diagram

WD - 0295 A10 (11.5.2010)



EU Declaration of Conformity - EU Conformiteitsverklaring EU Konformitätserklärung - Declaration de Conformite CE

  <p>EU DECLARATION OF CONFORMITY We hereby declare that the following equipment fulfils all the relevant provisions of: Machinery Directive 2006/42/EC EMC Directive 2004/108/EC</p> <p>Machine Description: Scrubber Drier Type: TTB series Manufactured by: Numatic International Limited</p> <p>This equipment has been designed and manufactured in accordance with the following harmonised European standards: IEC 60335-1:2002/a2:2006 IEC 60335-2-72/A1:2005</p> <p>EN 55014-1:2006 EN55014-2:1997/A2:2007 BS EN 50366:2003</p> <p>A technical construction file for this equipment is retained at the manufacturer's address.</p> <p>Signed:  Date: 11/06/2010 Name: Allyn Boyes Position: Technical Manager</p> <p>Numatic International Limited, Chard, Somerset. TA20 2GB www.numatic.co.uk</p> <p>GB</p>	  <p>EU-Konformitätserklärung Wir erklären hiermit, dass nachstehende Geräte die Ausführungen folgender Richtlinien erfüllen: Maschinenrichtlinie 2006/42/EC Richtlinie 2004/108/EC elektromagnetische Verträglichkeit</p> <p>Gerätebeschreibung: Scrubber Drier Modell: TTB Serien Hergestellt von: Numatic International Limited</p> <p>Die Geräte wurden gemäß folgender harmonisierter europäischer Normen entwickelt und hergestellt: IEC 60335-1:2002/a2:2006 IEC 60335-2-72/A1:2005</p> <p>EN 55014-1:2006 EN55014-2:1997/A2:2007 BS EN 50366:2003</p> <p>Eine technische Dokumentation ist an der Herstelleradresse hinterlegt.</p> <p>Unterschrift:  Datum: 11/06/2010</p> <p>Name: Allyn Boyes Titre : Responsable technique Numatic International Limited, Chard, Somerset. TA20 2GB www.numatic.co.uk</p> <p>DE</p>	  <p>DECLARATION DE CONFORMITE CE Nous soussignés déclarons que l'équipement ci-dessous satisfait aux dispositions suivantes: Machinery Directive 2006/42/EC EMC Directive 2004/108/EC</p> <p>Description: Scrubber Drier Type: Séries TTB Fabriqué par: Numatic International Limited</p> <p>Cet équipement a été dessiné et fabriqué dans le respect des normes européennes suivantes: IEC 60335-1:2002/a2:2006 IEC 60335-2-72/A1:2005</p> <p>EN 55014-1:2006 EN55014-2:1997/A2:2007 BS EN 50366:2003</p> <p>Un dossier technique de fabrication attaché à cet équipement est disponible à l'adresse du fabricant.</p> <p>Alle-kirjoitus  Date: 11/06/2010</p> <p>Nom: Allyn Boyes Titre : Responsable technique Numatic International Limited, Chard, Somerset. TA20 2GB www.numatic.co.uk</p> <p>FR</p>
  <p>EU CONFORMITEITSVERKLARING Wij verklaren hierbij dat de volgende producten zijn ontwikkeld en geproduceerd in overeenstemming met de volgende normen en voorschriften: Machinery Directive 2006/42/EC EMC Directive 2004/108/EC</p> <p>Machine Omschrijving: Scrubber Drier Type: TTB series Geproduceerd door: Numatic International Limited</p> <p>Deze producten zijn ontworpen en geproduceerd in overstemming met de volgende Europese standaarden: IEC 60335-1:2002/a2:2006 IEC 60335-2-72/A1:2005</p> <p>EN 55014-1:2006 EN55014-2:1997/A2:2007 BS EN 50366:2003</p> <p>De volledige productomschrijving en specificaties van de constructie zijn op aanvraag beschikbaar bij de fabrikant.</p> <p>Handtekening:  Datum: 11/06/2010</p> <p>Naam: Allyn Boyes Functie: Technical Manager</p> <p>Numatic International Limited, Chard, Somerset. TA20 2GB www.numatic.co.uk</p> <p>NL</p>	  <p>EU DECLARACION DE CONFORMIDAD DECLARAÇÃO DE CONFORMIDADE CE Declaramos que los siguientes equipos cumplen con las normativas que se detallan: Normativa de Maquinaria 2006/42/EC Normativa EMC 2004/108/EC</p> <p>Descripción de la Máquina: Scrubber Drier Modelo: TTB series Fabricado por: Numatic International Limited</p> <p>Este equipo ha sido diseñado y fabricado de acuerdo a los siguientes estándares europeos: IEC 60335-1:2002/a2:2006 IEC 60335-2-72/A1:2005</p> <p>EN 55014-1:2006 EN55014-2:1997/A2:2007 BS EN 50366:2003</p> <p>El fabricante dispone de una ficha técnica de esta máquina.</p> <p>Firmado:  Techa: 11/06/2010</p> <p>Nombre: Allyn Boyes Cargo: Technical Manager</p> <p>Numatic International Limited, Chard, Somerset. TA20 2GB www.numatic.co.uk</p> <p>ES</p>	  <p>DECLARAÇÃO DE CONFORMIDADE CE Declara-se que o seguinte equipamento preenche os seguintes requisitos: Directiva de Máquinas 2006/42/EC Directiva EMC 2004/108/EC</p> <p>Descrição da máquina : Scrubber Drier Modelos : série TTB Fabricado por : Numatic International Limited</p> <p>Este equipamento foi concebido e fabricado em conformidade com os standards harmonizados Europeus : IEC 60335-1:2002/a2:2006 IEC 60335-2-72/A1:2005</p> <p>EN 55014-1:2006 EN55014-2:1997/A2:2007 BS EN 50366:2003</p> <p>Uma ficha técnica sobre a construção deste equipamento encontra-se na morada do fabricante.</p> <p>Assinado:  Data: 11/06/2010</p> <p>Nome: Allyn Boyes Posição: Director Técnico</p> <p>Numatic International Limited, Chard, Somerset. TA20 2GB www.numatic.co.uk</p> <p>PT</p>
  <p>EU DECLARATION OF CONFORMITY We hereby declare that the following equipment fulfils all the relevant provisions of: Machinery Directive 2006/42/EC EMC Directive 2004/108/EC</p> <p>Machine Description: Scrubber Drier Type: TTB series Manufactured by: Numatic International Limited</p> <p>This equipment has been designed and manufactured in accordance with the following harmonised European standards: IEC 60335-1:2002/a2:2006 IEC 60335-2-72/A1:2005</p> <p>EN 55014-1:2006 EN55014-2:1997/A2:2007 BS EN 50366:2003</p> <p>A technical construction file for this equipment is retained at the manufacturer's address.</p> <p>Signed:  Date: 11/06/2010 Name: Allyn Boyes Position: Technical Manager</p> <p>Numatic International Limited, Chard, Somerset. TA20 2GB www.numatic.co.uk</p> <p>NO</p>	  <p>EU Försäkran Om Överensstämmelse Härmed förklarar vi att följande utrustning uppfyller alla relevanta villkor av: Maskin Direktiv 2006/42/EC EMC Direktiv 2004/108/EC</p> <p>Maskin Beskrivning: Scrubber Drier Typ: TTB serien Tillverkad av: Numatic International Limited</p> <p>Den här utrustningen är designad och tillverkad efter överenskomelse med följande Europeiska standarder: IEC 60335-1:2002/a2:2006 IEC 60335-2-72/A1:2005</p> <p>EN 55014-1:2006 EN55014-2:1997/A2:2007 BS EN 50366:2003</p> <p>En teknisk konstruktionsmapp för denna utrustning är bevarad hos tillverkarens adress.</p> <p>Signatur:  Datum: 11/06/2010</p> <p>Namn: Allyn Boyes Position: Teknisk Chef</p> <p>Numatic International Limited, Chard, Somerset. TA20 2GB www.numatic.co.uk</p> <p>SE</p>	  <p>ΔΗΛΩΣΗ ΣΥΜΜΟΡΦΩΣΗΣ ΜΕ ΕΕ We hereby declare that the following equipment fulfils all the relevant provisions of: Machinery Directive 2006/42/EC EMC Directive 2004/108/EC</p> <p>Περιγραφή προϊόντος: Scrubber Drier Τύπος: TTB series Κατασκευαστής: Numatic International Limited</p> <p>Η συσκευή αυτή σχεδιάστηκε και κατασκευάστηκε έτσι ώστε να πληροί τις ελάχιστες εναρμονισμένες ευρωπαϊκές προδιαγραφές: IEC 60335-1:2002/a2:2006 IEC 60335-2-72/A1:2005</p> <p>EN 55014-1:2006 EN55014-2:1997/A2:2007 BS EN 50366:2003</p> <p>Ο κατασκευαστής διατηρεί αρχείο του κατασκευαστικού σχεδίου της συσκευής αυτής.</p> <p>Υπογραφή:  Ημερομηνία: 11/06/2010</p> <p>Όνοματεπώνυμο: Allyn Boyes Θέση Τεχνικός Διευθυντής</p> <p>Numatic International Limited, Chard, Somerset. TA20 2GB www.numatic.co.uk</p> <p>GR</p>

  <p>EU- OVERENSSTEMMELSESERKLÆRING</p> <p>Vi erklærer herved, at følgende udstyr opfylder alle de relevante bestemmelser i:</p> <p>Maskiner Direktiv 2006/42/EF EMC-direktiv 2004/108/EF</p> <p>Beskrivelse af maskine: Scrubber Drier Type: TTB serie Fremstillet af: NUMATIC International Limited</p> <p>Denne udstyr er designet og fremstillet i overensstemmelse med følgende harmoniserede europæiske standarder: IEC 60335-1:2002/a2:2006 IEC 60335-2-72/A1:2005</p> <p>EN 55014-1:2006 EN55014-2:1997/A2:2007 BS EN 50366:2003</p> <p>En teknisk konstruktion for dette udstyr er bevaret på fabrikanterens adresse.</p> <p>Underskrevet:  Date: 11/06/2010</p> <p>Navn: Allyn Boyes Stilling: Teknisk chef</p> <p>Numatic International Limited, Chard, Somerset. TA20 2GB www.numatic.co.uk</p> <p>DK</p>	  <p>DICHIARAZIONE DI CONFORMITÀ EU</p> <p>Con la presente dichiariamo che i seguenti macchinari adempiono a tutte le disposizioni inerenti a:</p> <p>Direttiva Macchine 2006/42/EC EMC Direttiva 2004/108/EC</p> <p>Descrizione Macchina: Scrubber Drier Tipo: serie TTB Prodotto da: Numatic International Limited</p> <p>Questo apparecchio è stato ideato e prodotto in conformità con i seguenti concordati standard europei:</p> <p>IEC 60335-1:2002/a2:2006 IEC 60335-2-72/A1:2005</p> <p>EN 55014-1:2006 EN55014-2:1997/A2:2007 BS EN 50366:2003</p> <p>Un file relativo alla tecnica di costruzione di questo apparecchio viene conservato all'indirizzo del costruttore.</p> <p>Firmato:  Date: 11/06/2010</p> <p>Nome: Allyn Boyes Posizione: Responsabile Tecnico</p> <p>Numatic International Limited, Chard, Somerset. TA20 2GB www.numatic.co.uk</p> <p>IT</p>	  <p>EU VAATIMUSTENMUKAISUUSVAKUUTUS</p> <p>Me täten vakuutamme, että seuraava laite täyttää kaikki asiaa koskevat säännökset:</p> <p>Normativa de Maquinaria 2006/42/EC Normativa EMC 2004/108/EC</p> <p>Koneen kuvaus: Scrubber Drier Tyyppi: TTB series Valmistaja: Numatic International Limited</p> <p>Tämä laite on suunniteltu ja valmistettu noudattaen seuraavia yhdenmukaistettuja eurooppalaisia standardeja.</p> <p>IEC 60335-1:2002/a2:2006 IEC 60335-2-72/A1:2005</p> <p>EN 55014-1:2006 EN55014-2:1997/A2:2007 BS EN 50366:2003</p> <p>Tämän laitteen teknistä rakennetiedostoa säilytetään valmistajan osoitteessa.</p> <p>Alle-kirjoitus  Päivä: 11/06/2010</p> <p>Nimi: Allyn Boyes Position: Tekninen Johtaja</p> <p>Numatic International Limited, Chard, Somerset. TA20 2GB www.numatic.co.uk</p> <p>FI</p>
  <p>Europejska Deklaracja Zgodności</p> <p>Oświadczamy, że następujący sprzęt spełnia wszystkie odpowiednie przepisy:</p> <p>Dyrektywa dotycząca maszyn 2006/42/EC Dyrektywa kompatybilności elektromagnetycznej EMC 2004/108/EC</p> <p>Machine Omschrijving: Scrubber drier Type: TTB series Geproduceerd door: Numatic International Limited</p> <p>Sprzet ten został zaprojektowany oraz wyprodukowany zgodnie z normami i standardami:</p> <p>IEC 60335-1:2002/a2:2006 IEC 60335-2-72/A1:2005</p> <p>EN 55014-1:2006 EN55014-2:1997/A2:2007 BS EN 50366:2003</p> <p>Pełna dokumentacja techniczna dotycząca norm i dyrektyw jest przechowywana przez producenta sprzętu.</p> <p>Podpis:  Data: 11/06/2010</p> <p>Imię i nazwisko: Allyn Boyes Stanowisko: Technical Manager Numatic International Limited, Chard, Somerset. TA20 2GB www.numatic.co.uk</p> <p>PL</p>	  <p>DECLARATIE UE DE CONFORMITATE</p> <p>Noi, Numatic International Limited, cu sediul in Chard, Somerset, United Kingdom, nr de inregistrare: 773331 England, declaram pe proprie raspundere ca produsele:</p> <p>Machinery Directive 2006/42/EC EMC Directive 2004/108/EC</p> <p>Denumire: Scrubber Drier Tip/serii: TTB Fabricate de: Numatic International Limited</p> <p>la care se refera aceasta declaratie respecta cerintele de productie si sunt in conformitate cu urmatoarele standarde europene:</p> <p>IEC 60335-1:2002/a2:2006 IEC 60335-2-72/A1:2005</p> <p>EN 55014-1:2006 EN55014-2:1997/A2:2007 BS EN 50366:2003</p> <p>pot fi comercializate, avand marcajul de conformitate CE aplicat de producator.</p> <p>Documentatia tehnica de fabricare a acestui echipament se afla la fabricant</p> <p>Semnatura:  Date: 11/06/2010</p> <p>Funcție: Director Tehnic</p> <p>Numatic International Limited, Chard, Somerset. TA20 2GB www.numatic.co.uk</p> <p>RO</p>	  <p>EL-İ VASTAVUSAVALDUS</p> <p>Käesolevaga deklareerime, et järgmine seade on vastavuses kõigi alljärgnevat direktiivide asjassepuutuvate sätetega:</p> <p>Masinate direktiiv 2006/42/EÜ Elektromagnetilise ühilduvuse (EMC) direktiiv 2004/108/EÜ</p> <p>Masina kirjeldus: Scrubber Drier Tüüp: TTB sari Tootja: Numatic International Limited</p> <p>Seade on konstrueeritud ja toodetud vastavuses alljärgnevat ühtlustatud Euroopa standarditega:</p> <p>IEC 60335-1:2002/a2:2006 IEC 60335-2-72/A1:2005</p> <p>EN 55014-1:2006 EN55014-2:1997/A2:2007 BS EN 50366:2003</p> <p>Selle seadme tehnilist dokumentatsiooni hoitakse tootja aadressil.</p> <p>Allkiri:  Kuupäev: 11/06/2010</p> <p>Nimi: Allyn Boyes Amet: Tehniline juht</p> <p>Numatic International Limited, Chard, Somerset. TA20 2GB www.numatic.co.uk</p> <p>EE</p>
  <p>DEKLARACE SHODY S EU</p> <p>Tímto prohlašujeme, že následující zařízení splňuje příslušná ustanovení následujících dokumentů:</p> <p>Směrnice 2006/42/EC pro strojní zařízení Směrnice 2004/108/EC o elektromagnetické kompatibilitě</p> <p>Popis zařízení: Scrubber Drier Typ: řada TTB Výrobce: Numatic International Limited</p> <p>Toto zařízení bylo zkonstruováno a vyrobeno v souladu s následujícími harmonizovanými evropskými normami:</p> <p>IEC 60335-1:2002/a2:2006 IEC 60335-2-72/A1:2005</p> <p>EN 55014-1:2006 EN55014-2:1997/A2:2007 BS EN 50366:2003</p> <p>Technická konstrukční dokumentace k tomuto zařízení je k dispozici na adrese výrobce.</p> <p>Podpis:  Datum: 11/06/2010</p> <p>Jméno: Allyn Boyes Pozice: Technický ředitel:</p> <p>Numatic International Limited, Chard, Somerset. TA20 2GB www.numatic.co.uk</p> <p>CZ</p>	  <p>EU MEGFELELŐSÉGI NYILATKOZAT</p> <p>Ezennel kijelentjük, hogy a készülék megfelel a következő irányelvek összes hatályos rendelkezésének:</p> <p>Cépre vonatkozó 2006/42/EK irányelv Elektromágnesség összeférhetőségére vonatkozó 2004/108/EK irányelv</p> <p>A gép megnevezése: Scrubber Drier Típus: TTB sorozat Gyártó: Numatic International Limited</p> <p>A készülék tervezése és gyártása a következő harmonizált európai szabványokkal összhangban történt:</p> <p>IEC 60335-1:2002/a2:2006 IEC 60335-2-72/A1:2005</p> <p>EN 55014-1:2006 EN55014-2:1997/A2:2007 BS EN 50366:2003</p> <p>A készülékhez műszaki dokumentáció áll rendelkezésre a gyártó címén.</p> <p>Aláírás:  Dátum: 11/06/2010</p> <p>Név: Allyn Boyes Beosztás: műszaki igazgató</p> <p>Numatic International Limited, Chard, Somerset. TA20 2GB www.numatic.co.uk</p> <p>HU</p>	  <p>ЕС ДЕКЛАРАЦИЯ ЗА СЪОТВЕТСТВИЕ</p> <p>С настоящето декларираме, че следното оборудване удовлетворява всички приложими изисквания на:</p> <p>Директива "Машини" 2006/42/EC Директива за електромагнитна съвместимост 2004/108/EC</p> <p>Описание на машината: Scrubber Drier Тип: Серия TTB Произведена от: Numatic International Limited</p> <p>Това оборудване е конструирано и произведено в съответствие с изискванията на следните хармонизирани Европейски стандарти:</p> <p>IEC 60335-1:2002/a2:2006 IEC 60335-2-72/A1:2005</p> <p>EN 55014-1:2006 EN55014-2:1997/A2:2007 BS EN 50366:2003</p> <p>Файл за техническата конструкция на това оборудване се съхранява на адреса на производителя..</p> <p>Подпис:  Дата: 11/06/2010</p> <p>Име: Allyn Boyes Титле : Responsable technique</p> <p>Numatic International Limited, Chard, Somerset. TA20 2GB www.numatic.co.uk</p> <p>BG</p>

**ES ATITIKIMO DEKLARACIJA**

Šiuo dokumentu patvirtiname, kad ši įranga atitinka sekancijų direktyvų reikalavimus:
 Įrengimų Direktyva 2006/42/E
 EMC Direktyva 2004/108/ES

Įrenginio Aptašymas: **Scrubber Drier**
 Tipas: **TTB series**
 Gamintojas: **Numatic International Limited**

Ši įranga sukonstruota ir pagaminta pagal sekancius, atitinkančius Europos standartus:

IEC 60335-1:2002/a2:2006
 IEC 60335-2-72/A1:2005

EN 55014-1:2006
 EN55014-2:1997/A2:2007
 BS EN 50366:2003

Techninė šio įrenginio dokumentacija yra saugoma gamintojo.

Patvirtinta:  Data: 11/06/2010

V.Pavardė: Allyn Boyes Pareigos: Tehniline juht

LT

Numatic International Limited,
 Chard, Somerset,
 TA20 2GB
 www.numatic.co.uk

**DEKLARACIJA EU O SKLADNOSTI**

Izjavljamo, da je ta oprema skladna z vsemi potrebnimi določbami:
 Direktiva 2006/42/ES o strojih
 Direktiva 2004/108/ES o elektromagnetni združljivosti

Opis aparata: **Scrubber Drier**
 Vrsta: serije **TTB**
 Proizvajalec: **Numatic International Limited**

Aparat je oblikovan in izdelan v skladu z naslednjimi usklajenimi evropskimi standardi:

IEC 60335-1:2002/a2:2006
 IEC 60335-2-72/A1:2005

EN 55014-1:2006
 EN55014-2:1997/A2:2007
 BS EN 50366:2003

Tehnični podatki o tej opremi so na voljo pri proizvajalcu.

Podpis:  Datum: 11/06/2010

ime: Allyn Boyes Funkcija: Tehnični direktor

SI

Numatic International Limited,
 Chard, Somerset,
 TA20 2GB
 www.numatic.co.uk



Affix Label Here

Product serial number



Pass stamp

Distributed by:



TTB 3450/100S



Numatic International Limited, Chard, Somerset, TA20 2GB, ENGLAND.

Telephone 01460 68600 Fax: 01460 68458

www.numatic.co.uk



Numatic International GmbH, Fränkische Straße 15-19,
30455 Hannover, DEUTSCHLAND.

Tel: 05 11 98 42 16 0 Fax: 05 11 98 42 16 20

www.numatic.de



Numatic International S.A., 13/17 rue du Valengelier, EAE la Tuilerie, 77500
Chelles, FRANCE. Tel: 01 64 72 61 61 Fax: 01 64 72 61 62

www.numatic.fr



BenNeLux Distribution, Numatic International BV, Postbus 101, 2400 AC
Alphen den Rijn, NEDERLAND. Tel: 0172 467 999 Fax : 0172 467 970

www.numatic.nl



Numatic International (Pty.) Ltd. 16th & Pharmaceutical Roads,
Midrand, Gauteng, S.A. 1685. Tel: 0861 686 284 Fax: 0861 686 329

www.numatic.co.za



Numatic International Schweiz AG. Sihlbruggstrasse 142,
6340 Baar. SCHWEIZ. Tel: 0041 (0) 41 76 80 76 - 0.

Fax: 0041 (0) 41 76 80 76 - 9.

www.numatic.ch

Specification subject to change without prior notice.

www.numatic.co.uk © Numatic International Limited