

Owner Instructions  
Mode d'emploi

**TTB 516**  
(TTB 1840)



**NACECARE**

*Original Instructions*  
**Warning! Read instructions before using the machine.**

*Attention*  
**Lisez la notice avant d'utiliser la machine.**





Before continuing, please refer to Quick Set Up Guide on Page 8



<b>Index</b>	Page 2
<b>Machine overview</b>	Page 3
<b>Control panel overview</b>	Page 4
<b>Rating label / Personal Protective Equipment / Recycling</b>	Page 5
<b>Safety Precautions</b>	Page 6 / 7
<b>Quick set-up guide</b>	<b>Page 8</b>
<b>Machine set-up</b>	
Fitting the brushes	Page 9
Fitting the floor tool	Page 9
Filling the clean-water tank	Page 10
Fill level indicator	Page 10
Control of Substances Hazardous to Health (COSHH)	Page 11
Water flow adjustment	Page 11
Pre-cleaning advice	Page 11
Moving the Machine	Page 12
<b>Machine Operation</b>	
Pre-scrub mode	Page 13
Floor tool in use	Page 13
Hi-Lo setting	Page 13
Setting the cleaning controls	Page 14
Brush overload (Over Current)	Page 14
<b>Regular Maintenance</b>	
Cleaning Tanks and Filters	Page 15
Removing / replacing the clean-water tank	Page 16
Replacing the waste water tank	Page 16
Changing the floor-tool blades	Page 17
Refitting the floor-tool blades	Page 17
Battery care	Page 18
Removing the battery-pack fuse	Page 18
Machine Charging	Page 19
Trouble shooting / Specifications	Page 20
Recommended spare parts / Warranty	Page 21
Wiring diagrams	Page 22
Declaration document	Page 23
Company addresses	Page 24

# Machine Overview



- |  |  |
|--|--|
| 1. Operator control panel ( see page 4 ) | 12. Vacuum hose                          |
| 2. On / Off Lever                        | 13. Separator                            |
| 3. Waste water tank                      | 14. Clean-water filler cap               |
| 4. Clean water tank                      | 15. Clean-water level indicator          |
| 5. Brush deck                            | 16. Clean-water tank fill point          |
| 6. Squeegee blades                       | 17. On / Off switch                      |
| 7. Floor-tool retaining knobs            | 18. Battery connector                    |
| 8. Clean-water on / off tap              | 19. Top tank (waste water) drainage hose |
| 9. Clean-water emptying cap              | 20. Battery                              |
| 10. Rear moving wheels                   | 21. Spare / replacement battery          |
| 11. Floor-tool vacuum hose               |  |

# Control Panel Overview

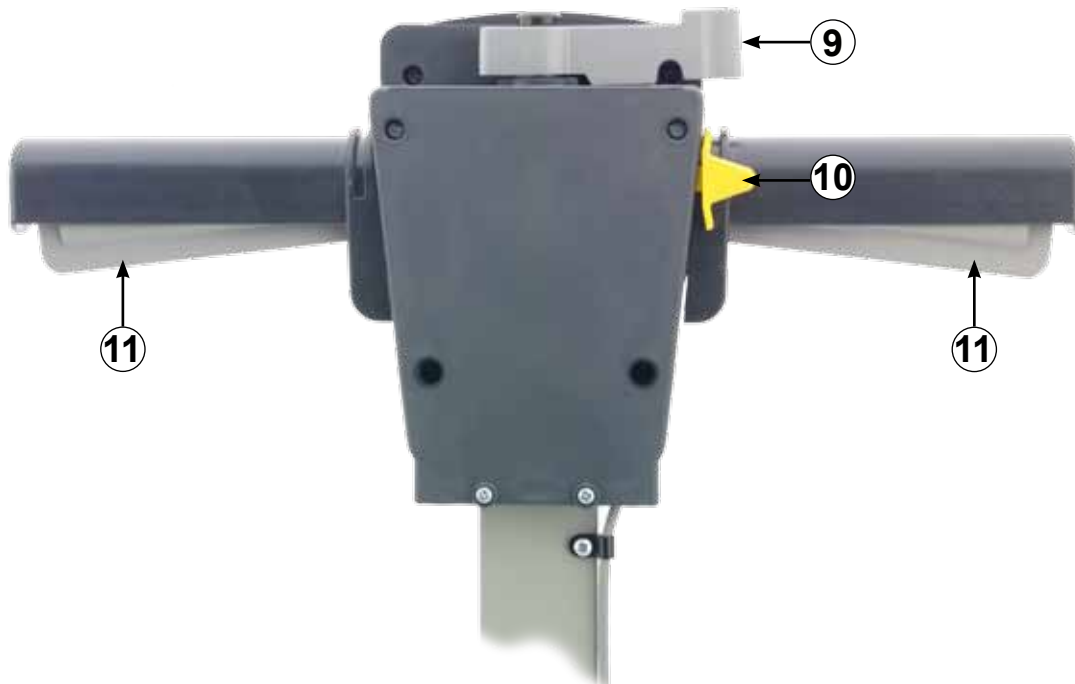
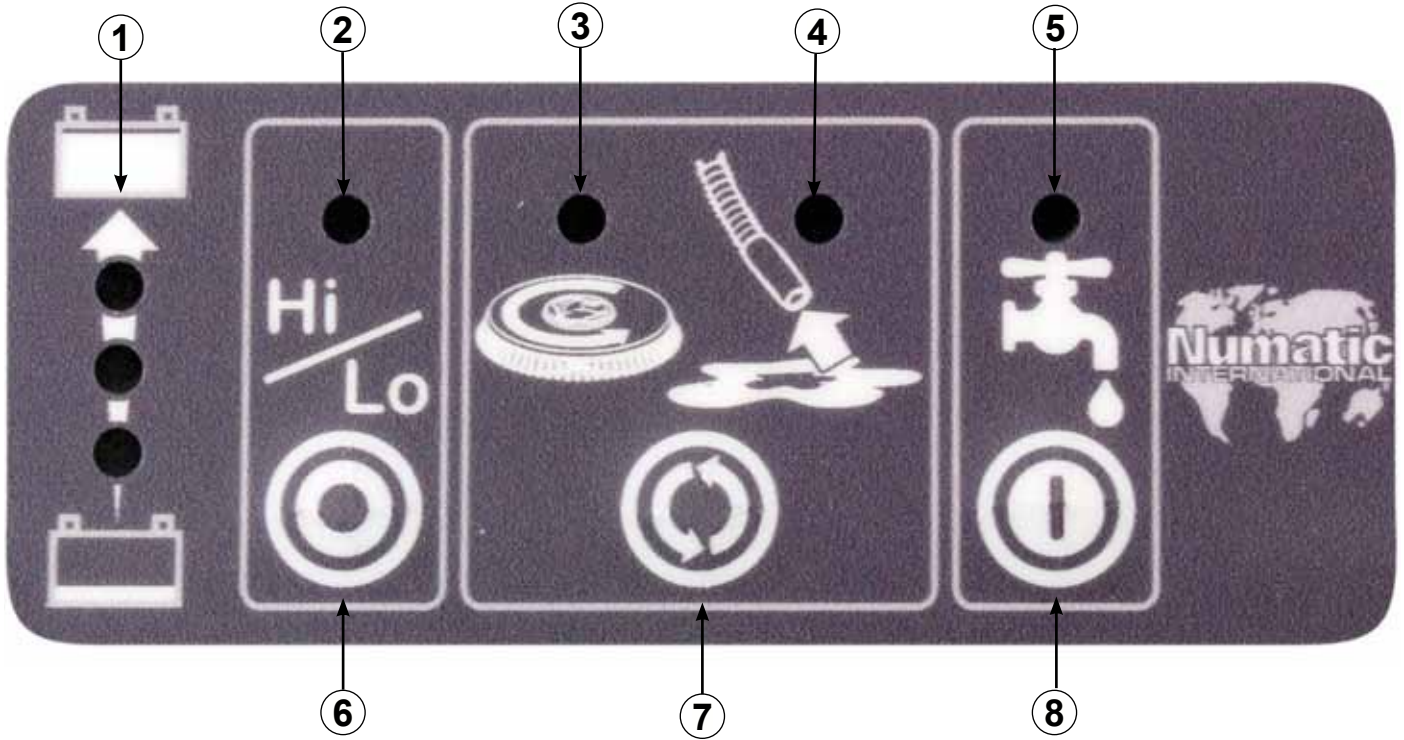

- |          |                                  |           |                            |
|----------|----------------------------------|-----------|----------------------------|
| <b>1</b> | Battery Charge Level Indicator   | <b>7</b>  | Cycle sequence button      |
| <b>2</b> | Hi / Lo Indicator                | <b>8</b>  | Water Flow On / Off Button |
| <b>3</b> | Brush Operation / Load Indicator | <b>9</b>  | Handle Position Lever      |
| <b>4</b> | Vacuum Indicator                 | <b>10</b> | On / Off Switch            |
| <b>5</b> | Water Flow Indicator             | <b>11</b> | On / Off Lever             |
| <b>6</b> | Hi / Lo Button                   |           |                            |

For full easy to follow  
Instructions on control panel set up and use,  
see machine operation set-up page 14

# About the Machine



Rating Label

<b>Numatic</b> International Ltd CHARD, ENGLAND, TA20 2GB	Company name and address
<b>TTB 516</b> (TTB 1840)	Machine description
700W    24V DC 18 Ahr	Power/ Voltage/ Frequency
70kg	Weight
IPX4	Splash proof rating
6%	Max gradient
100621036	Machine year / week / serial number



**Safety Critical Component**

Charging Lead: 18AWG x 3 core SVT Cable (Black)

Battery Charger: 100 - 240 Volt (50-60 Hz)

PPE  
(Personal protective equipment) that may be required for certain operations.

Ear Protection	Safety Footwear	Head Protection	Safety Gloves
Dust/Allergens Protection	Eye Protection	Protective Clothing	Hi-Vis Jacket



Caution floorsign

**Note:**  
A risk assessment should be conducted to determine which PPE should be worn.



ORIGINAL INSTRUCTIONS  
READ MANUAL BEFORE USE

## Information for Scrubber Dryer

Component	Interval	Inspect for
Charging Lead	DAILY	scuffing, cracks, splits, conductors showing
Brushes	DAILY	bristle damage, wear, drive collar wear
Squeegee Blade	BEFORE EACH USE	wear, cracks, splits
Filters	BEFORE EACH USE	clogging and debris retention
Tanks	AFTER EACH USE	rinse dirty water tank after use

### CAUTION:

Read the instruction manual before using the appliance.

This product meets the requirements of CSA / CAN 60335-2-72

### WARNING:

As with all electrical equipment care and attention must be exercised at all times during its use, in addition to ensuring that routine and preventative maintenance is carried out periodically in order to ensure its safe operation.

Failure to carry out maintenance as necessary, including the replacement of parts to the correct standard could render this equipment unsafe and the manufacturer can accept no responsibility or liability in this respect.

When ordering spare parts always quote the Model Number / Serial Number specified on the Rating Plate.

Warning do not use on slopes exceeding 6%.

This appliance is not intended for use by persons (including children) with reduced physical, sensory or mental capabilities, or lack of experience and knowledge, unless they have been given supervision or instruction concerning use of the appliance by a person responsible for their safety.

Children should be supervised to ensure that they do not play with the appliance.

### NOTE:

This machine is also suitable for commercial use, for example in hotels, schools, hospitals, factories, shops and offices for other than normal housekeeping purposes.

### CAUTION:

This machine is not suitable for picking-up hazardous dust.

Do not use on surfaces having a gradient exceeding that marked on the appliance.

The machine is not to be stored outdoors in wet conditions.

This machine is for indoor use only.

### DO'S AND DON'TS

DO ensure only competent persons unpack/assemble the machine.

DO keep your machine clean.

DO keep your brushes in good condition.

DO replace any worn or damaged parts immediately.

DO regularly examine the power cord for damage, such as cracking or ageing. If damage is found, replace the cord before further use.

DO only replace the power cord with the correct Numatic approved replacement parts.

DO ensure that the work area is clear of obstructions and / or people.

DO ensure that the working area is well illuminated.

DO pre-sweep the area to be cleaned.

DON'T use steam cleaners or pressure washers to clean the machine or use in the rain.

DON'T attempt machine maintenance or cleaning unless the power plug has been removed from the supply outlet.

DON'T allow any inexperienced repairs. Call the experts

DON'T strain cable or try to unplug by pulling on cable.

DON'T leave the brush pad on the machine when not in use.

DON'T allow the machine to be used by inexperienced or unauthorised operators or without appropriate training.

DON'T use the machine without the solution tanks properly positioned on the machine, as shown in the instructions.

DON'T expect the machine to provide trouble-free, reliable operation unless maintained correctly.

DON'T lift or pull the machine by any of the operating triggers - Use the main handle.

DON'T remove the handle from the machine except for service and repair.

## WARNING:

Only use brushes provided with the appliance or those specified in the instruction manual.

The use of other brushes may impair safety.

A full range of brushes and accessories are available for this product.

Only use brushes or pads which are suitable for the correct operation of the machine for the specific task being performed.

It is essential that this equipment is correctly assembled and operated in accordance with current safety regulations. When using the equipment always ensure that all necessary precautions are taken to guarantee the safety of the operator and any other persons who may be affected.

Wear non-slip footwear when scrubbing. Use a respiratory mask in dusty environments.

The machine, while charging, must be positioned so that the mains plug is easily accessible.

When cleaning, servicing or maintaining the machine, replacing parts or converting to another function the power source shall be switched off.

Mains operated machines shall be disconnected by removing the power plug, and battery operated machines shall be disconnected by removing the isolating pin (Battery pack).

Machines left unattended shall be secured against unintentional movement.

Operators shall be adequately instructed as to the correct use of the machine.

## PRECAUTIONS WHEN WORKING WITH BATTERIES

1. Always wear protective clothing e.g. face visor, gloves and overalls when working with batteries
2. Whenever possible always use a properly designated and well-ventilated area for charging. Do not smoke or bring naked flames into the charging area.
3. Remove any metallic items from hands, wrists and neck i.e. rings, chains etc. before working on a battery.
4. Never rest tools or metallic objects on top of the battery.
5. When charging is complete disconnect from the mains supply.
6. The batteries must be removed from the machine before it is scrapped.
7. The machine must be disconnected from the supply when removing the battery.
8. The batteries are to be disposed of safely and in accordance with the battery directive.
9. Only use genuine NUMATIC replacement batteries.
10. Do not allow the batteries to become fully discharged; it may not be possible to recharge them. Batteries should not be discharged below 9.5 volts with 10 amps flowing.
11. Do not allow one battery to be discharged separately to the other.
12. Do not mix batteries from different machines.
13. The batteries fitted to this product are Valve Regulated Lead Acid (VRLA) gel electrolyte type. The fitting of any other type of battery may cause a safety hazard.

## BATTERY CARE

1. Always recharge the batteries after use. This can be done at any time its not necessary to wait until they are fully discharged; they do not develop a "memory".
2. Leaving the charger to operate for a minimum of 4 hours after the green light has come on, at least weekly, will prolong battery life.
3. Do not store the machine with the batteries discharged.



# Quick Set-Up Guide



## **PLEASE READ BEFORE COMMENCING ANY OPERATION.**

After the removal of all the packaging, carefully open and check the contents.  
Ensure the Batteries are charged before use.



Fig 1

Using the handle position lever, move the handle into the upright position. (Fig 1).



Fig 2

Fit the Brush / Pad (Fig 2).



Fig 3

Swing the floor-tool carrier from behind the brush. (Fig 3).



Fig 4

Using the two locking knobs fitted to the floor-tool, secure to the floor-tool to the floor-tool carrier. (Fig 4).



Fig 5

Fit the battery to the machine (Fig 5) and plug in the power supply. (Fig 5a). Ensure the battery has been charged before use.

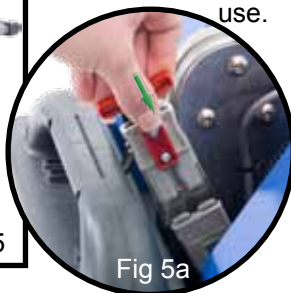

Fig 5a

Fill the clean-water to a Max of 18 litres  
(see page 10)

For operation and cleaning  
controls (see page 14)



# Machine Set-Up



**ALWAYS ENSURE THAT THE BATTERY IS DISCONNECTED BEFORE MAKING ANY ADJUSTMENTS**



## Fitting the brushes

Featuring the Nulock brush system.

The brush is simply pushed and twisted to lock, making fitting and removal a simple process.

Only use manufacturer supplied brushes.

This machine requires a 16 inch brush or a 16 inch pad.



Slide the brush / pad under the brush deck (Fig 6).



Fit the brush / pad onto the Nulock drive chuck, twist to lock the brush / pad in place (Fig 7).

**Safety gloves are recommended for the changing of used brushes.**

## Fitting the Floor Tool

The floor tool has been designed for quick fitting, allowing easy squeegee blade replacement and a safety knock-off feature if the floor tool gets snagged, whilst in transit.



Swing the floor-tool carrier to the side of the machine (Fig 8).

### *Note:*

*It is easier to fit the floor-tool if the weight of the machine is resting on the brush. Ensure the brush is fitted first.*



Secure to the carrier using the two knobs fitted to the floor-tool carrier (Fig 9) - (Fig 9a).

Do not over tighten the retaining knobs.



# Machine Set-Up

## Filling the clean-water tank

The TTB 516 is equipped with a large 5 US Gallons clean-water tank allowing large areas to be cleaning in a single fill.

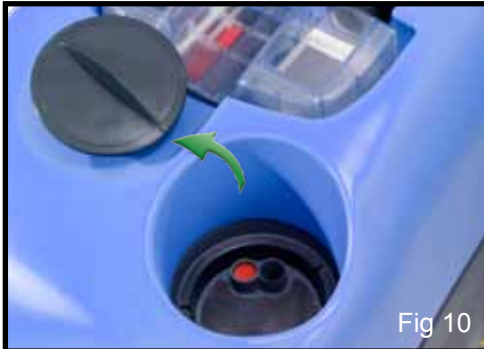

To fill the clean-water tank, remove the filler cap (Fig 10).



Fill using either a hose, bucket or a suitable container. (Fig 11).

### Note.

Great care must be taken to ensure that contaminants (leaves, hair, dirt, etc) are not allowed to enter the clean-water during the filling process.

If using a bucket or similar, ensure it is always clean and free from debris.

## Fill Level Indicator

Fill the clean water tank to a maximum of 5 US Gallons, including cleaning chemicals if required.

Follow chemical manufacturing guide lines.

This allows the machine to be tipped back and moved without spillage (see page 12).



Use the fill indicator (Fig 12).



Showing the clean-water tank empty (Fig 13).



Showing the clean-water tank full (Fig 13a).

# Machine Set-Up



## **WHEN HANDLING AND MIXING CHEMICALS.**

Always ensure that chemical manufacturers safety guidelines are followed.  
Only use chemicals recommended for use in auto scrubber-driers.



## **Control of Substances Hazardous to Health (COSHH)**

For best results use a non-foaming type of chemical, dilute to the manufacturers specification.  
For further guidance on hazardous substances refer to health and safety instructions online.  
Visit <http://www.hse.gov.uk/> for UK information.



## **Water Flow Adjustment**

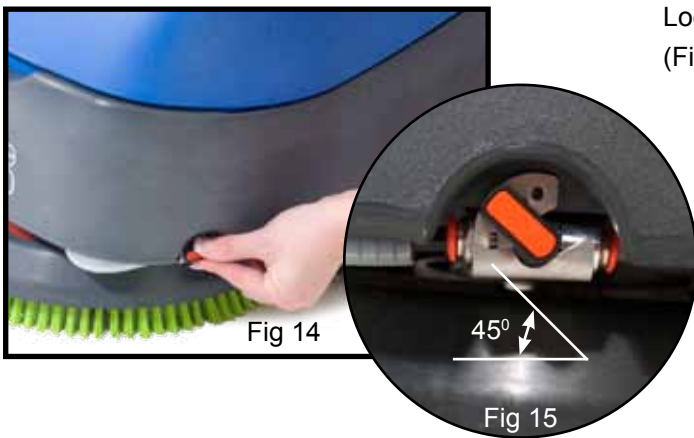

Located on the left of the machine is the On / Off water tap (Fig 14).

Ideally set the tap to 45° this enables the cleaning solution to last the same time as a fully-charged battery (Fig 15).



## **Important**

Do not operate machine unless the Operator Manual has been read and fully understood.



## **Pre-cleaning advice.**

Before performing the cleaning operation, place out appropriate warning signs and sweep or dust-mop the floor (Fig 16).



Numatic part (629044) Wet Floor sign  
(available if required)

Fig 16

# Machine Set-Up

## Moving the machine



**Caution**  
When moving or lifting the TTB 516, follow the national safety guidelines on lifting.



Fig 17

When the bottom tank (clean water) is full the machine can be tilted to a maximum of 45° (Fig 17).



Fig 18

When the top tank (waste water) is full the machine can be tilted to a maximum of 10° for transporting to dumping area (Fig 18).



Fig 19

Transport the machine by tilting back on to the main transit wheels (Fig 19).



Fig 20

Weight of empty machine (fig 20).

Without the battery pack:- 38.5Kg (85 lbs).

Battery pack weight:- 13.5Kg (30 lbs).

Complete machine :- 52Kg (115 lbs)



**Caution**  
Ensure both tanks are empty and the battery has been removed before attempting to lift the machine.



# Machine Operation

## Pre-scrub mode

The TTB -516 has been designed to cope with a variety of floor types and different levels of soiling.

On heavily soiled floors use a 'double scrub' technique.

First pre-scrub the floor with the floor-tool in the raised position (Fig 21), allow the chemical time to work, then scrub the area a second time with the floor-tool lowered.

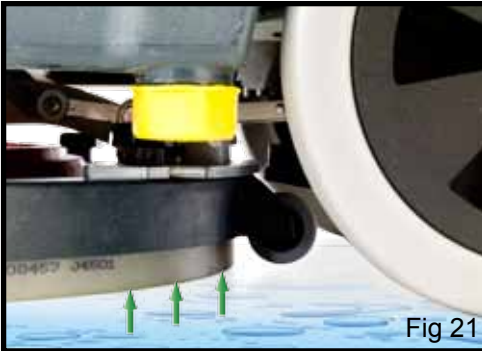

Fig 21

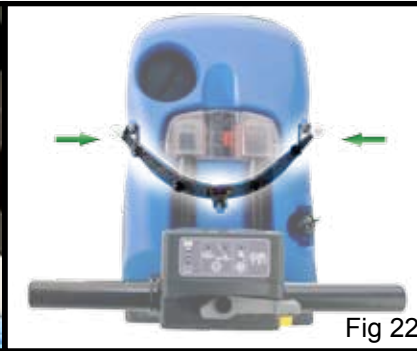

Fig 22



Fig 23

To raise the floor-tool, ensure the floor-tool carrier is central to the machine (Fig 22).

Lift the lever near the base of the handle and lock into position (Fig 23).

**Note** The lever moves upward and backward motion to lock the floortool in the raised position.

## Floor tool in use

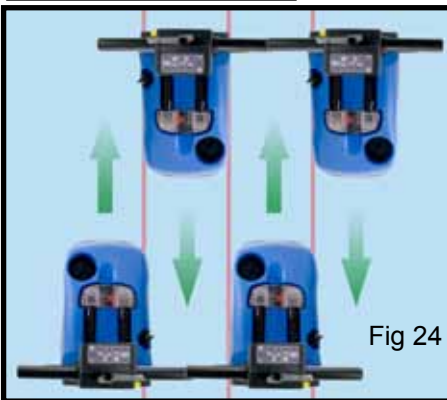

Fig 24

The clean-water / chemical mix is dispersed via 'THRU-FEED' system.

The waste water is then retrieved by the floor-tool (see page 9).

Overlap the scrubbing path by 10cm to ensure an even clean (Fig 24).

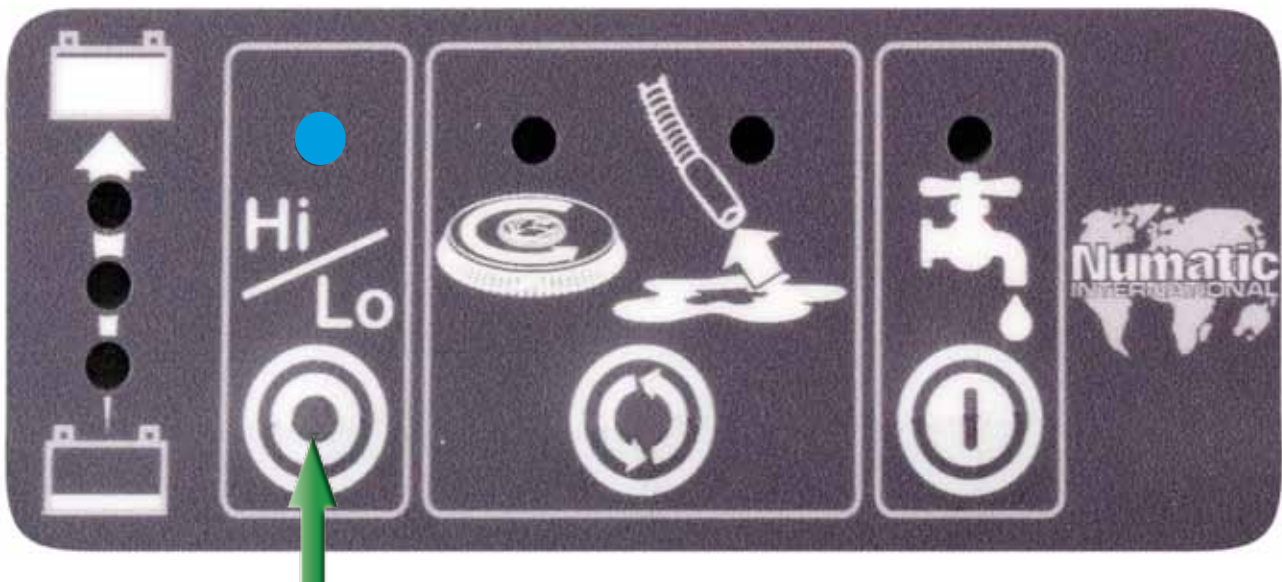

Fig 25

If streaking occurs, wipe the floor-tool blades clean (Fig 25).

**Note** Care must be taken to reduce speed when cornering or when manoeuvring around obstacles.

## Hi - Lo Setting



## Setting the cleaning controls

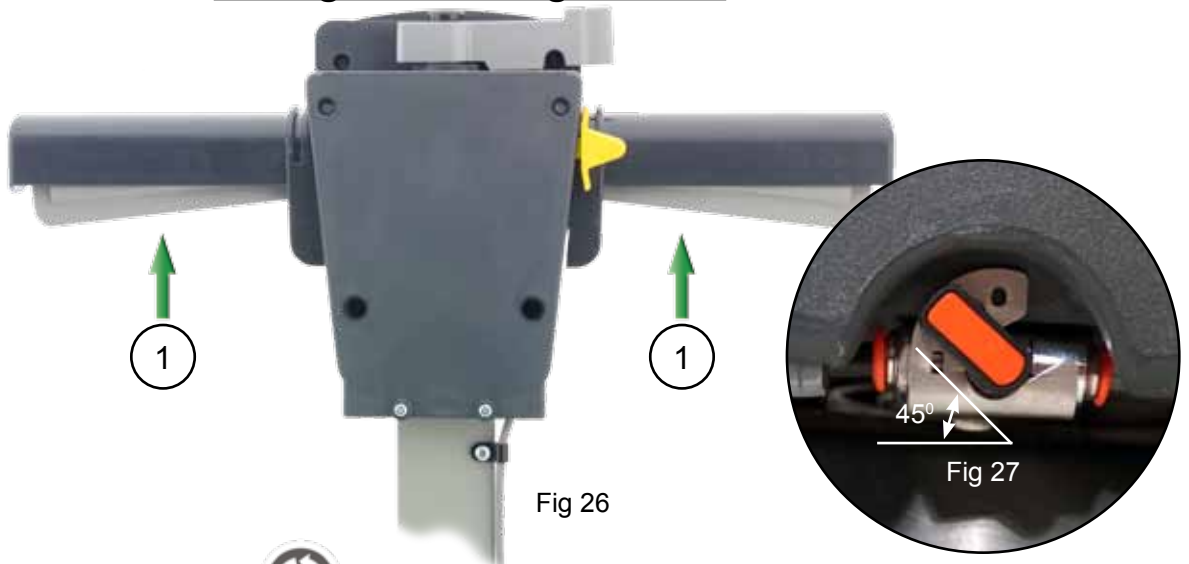
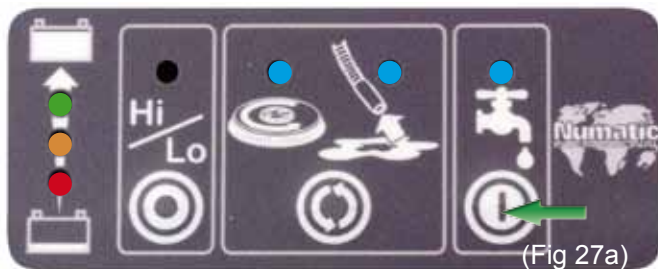

Fig 26

Fig 27

To activate the control panel: press the  cycle button or press a trigger (Fig 26).

To start: hold down either trigger and press the yellow start button once (Fig 26).



(Fig 27a)

Whilst the brush motor is running press the tap On / OFF button for fluid control (Fig 27a), the clean tank tap must be open.

Ideally set the tap to 45° (Fig 27) this enables the cleaning solution to last the same time as a fully-charged battery .

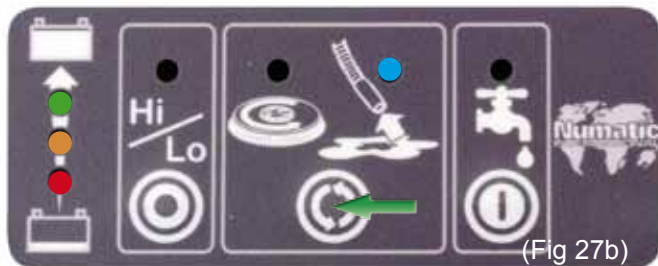

(Fig 27b)

When the triggers are released the brush motor and the cleaning solution pump will switch off, the vacuum motor will continue for 10 seconds.

Press the  cycle button to operate the brush only (Fig 27b).

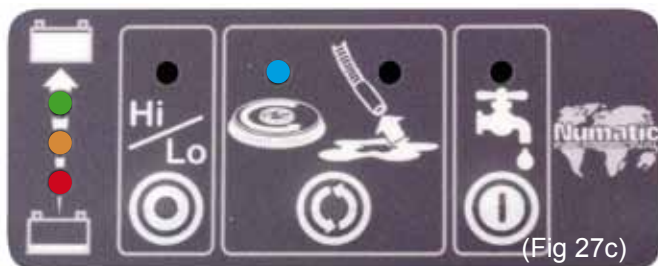

(Fig 27c)

The start sequence is required in this mode. The tap button will operate in this mode.

Press the cycle button again to get vacuum only. The start button and triggers are not required in this mode. (Fig 27c).

Press the cycle button to switch this mode off and return to default mode.

The panel if unused will automatically turn off after 60 seconds.



(Fig 27d)

### Brush overload.

The brush LED light will flash if the brush motor has been overloaded (Fig 27d).

Releasing the handle triggers will allow the machine to stop and reset.

If the brush motor keeps overloading consider using a different type of brush. Heavy brush load decreases the available battery run time.

# Regular Maintenance



**ALWAYS ENSURE THAT THE BATTERY IS DISCONNECTED  
PRIOR TO ANY MAINTENANCE OPERATION**



The TTB 516 has been designed with ease of use in mind, this included easy stripping-down and cleaning.



After use, empty waste-water tank using emptying hose and flush-out with clean water. **(A)**



Fig 28



Fig 29

Remove the two hoses to disconnect the separator from the machine (Fig 28).

Lift off the separator. The separator has a sealing-rubber which should be examined at every clean-down (Fig 29). Rinse using clean water.



Fig 30

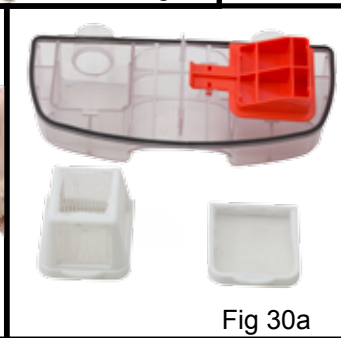

Fig 30a



Fig 31



Fig 32

Remove the two filters clipped into the separator and flush with clean water (Fig 30)(Fig 30a).

Replace by fitting the rear of the filter first then clipping the front to lock in place (Fig 31) (Fig 32).

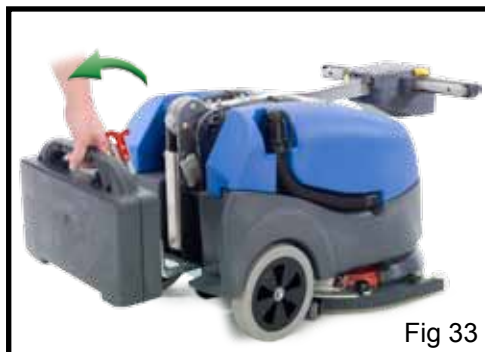

Fig 33



Fig 33a

Disconnect and remove the battery before proceeding with tank removal (Fig 33).

Once emptied the top waste-water tank can simply be lifted off. (Fig 33a).

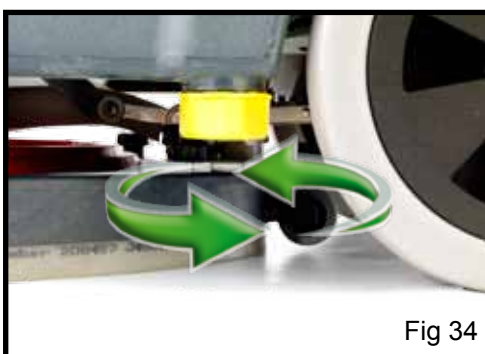

Fig 34

The clean-water tank can be drained via the yellow cap fitted to the left hand side of the machine. The cap has a rubber seal and might require a spanner to remove. (Fig 34).

**NOTE:**

Avoid over tightening the clean water draining cap.

# Regular Maintenance

## Removing the Clean Water Tank



Fig 35



Fig 36

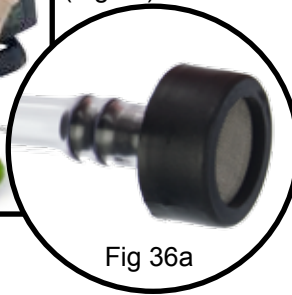

Fig 36a

Once the clean-water tank has been emptied, the tank can be removed.

Firstly detach the water feed pipe from the tap, this can be done by pushing the red tap clip in whilst pulling off the pipe. (Fig 35).

The black suction hose from the floor-tool simply pulls off the floor tool (Fig 36).

Inside the clean water tank is a filter, located below the clean water inlet (Fig 36a)

Clean all hoses and filters by flushing with clean water.

## Replacing the Clean Water Tank



Fig 37



Fig 37a

Fit the suction hose to the floor tool (Fig 37) and pass through the hole in the clean water tank (Fig 37a).

Place the tank onto the machine base.

**NOTE:**

Ensure the water feed pipe locates in the channel moulded into the base of the tank (Fig 38).

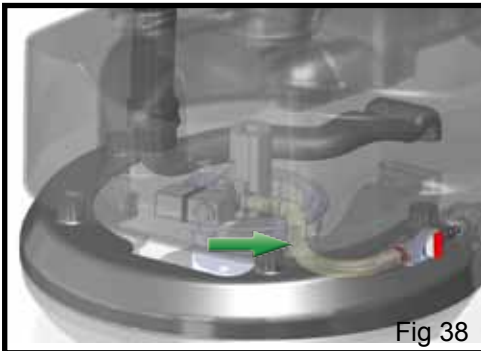

Fig 38

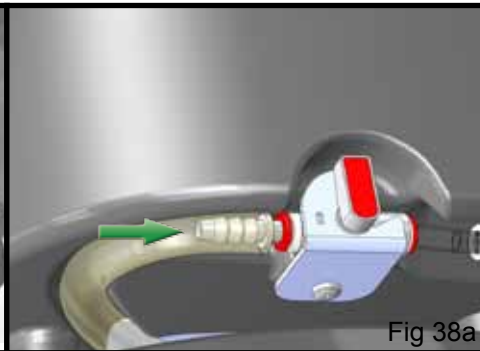

Fig 38a

The water feed pipe simply pushes onto the tap. (Fig 38a).

## Replacing the Waste Water Tank



Fig 39



Fig 39a

Place the suction hose as shown (Fig 39).

Place the tank onto the machine (Fig 39a).



Fig 40

Refit the separator and reconnect the vacuum and suction hose (Fig 40).



# Changing the Floor-Tool Blades



**ALWAYS ENSURE THAT THE BATTERY IS DISCONNECTED PRIOR TO ANY MAINTENANCE**



Fig 41

To change the floor-tool, firstly swing the floor-tool clear of the machine (Fig 41).

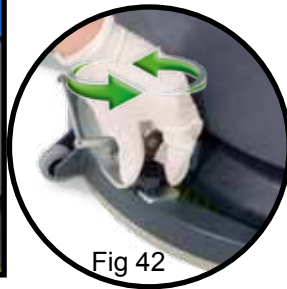

Fig 42

Undo the two floor-tool retaining knobs (Fig 42).

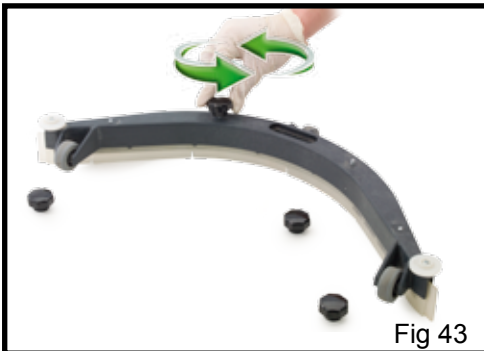

Fig 43

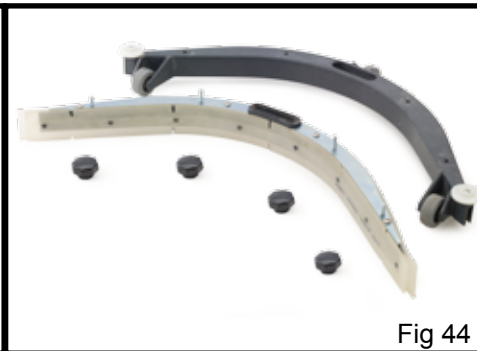

Fig 44

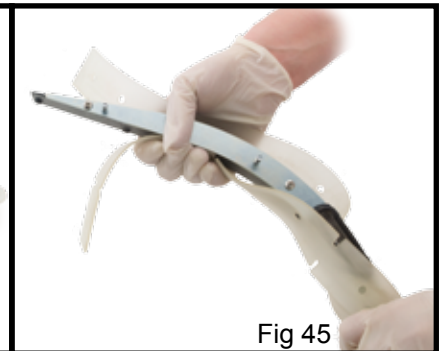

Fig 45

Unscrew the four knobs securing the blade holder (Fig 43).

Remove the blade holder (Fig 44).

Replace the Squeegee blades using (606261) replacement blade set (Fig 45), fitting the blades on to the moulded location lugs.

## Refitting the Floor Tool Blades

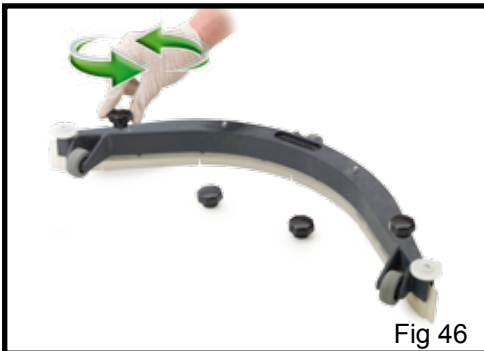

Fig 46

Refit the blade holder, retain using the two outer knobs (Fig 46)

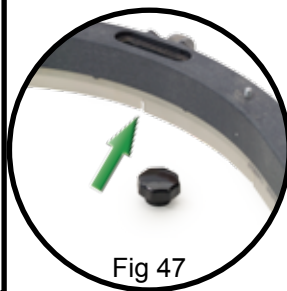

Fig 47

Ensure the slotted blade goes to the front of the floor-tool (Fig 47).

**Note:**

The blades are designed to be reversible, thus extending their useful working life.

Refit the floor-tool using the two central knobs to the floor-tool.

*Refer to Page 9 for fitting instructions.*

1. Floor-tool main body
2. Blade carrier
3. Rear blade
4. Front blade (slotted)
5. Retaining Knobs x 4

Use Genuine NUMATIC spare parts.  
use  
Replacement Blade Set (606261)



# Battery Care

## Removing the battery

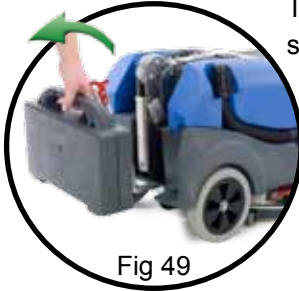

Unplug the battery from the machine using the red connection handle (Fig 48).  
The battery can then be lifted from the machine for storage or charging (Fig 49).

## Removing the battery pack fuse



The battery pack comes with a 40 amp safety fuse fitted (Fig 50).

Remove the six screws holding the battery pack together (Fig 51).

Split the pack and replace the fuse using (208526) Numatic approved part (Fig 52).

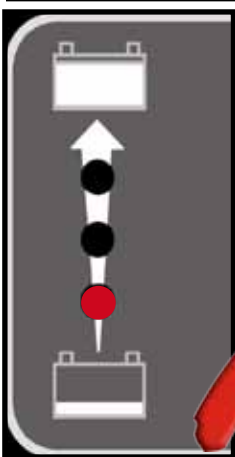
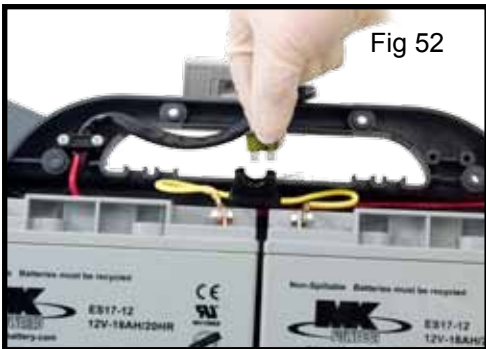

Recharge the machine fully after its last use.

**Do not leave the machine in a discharged state.**

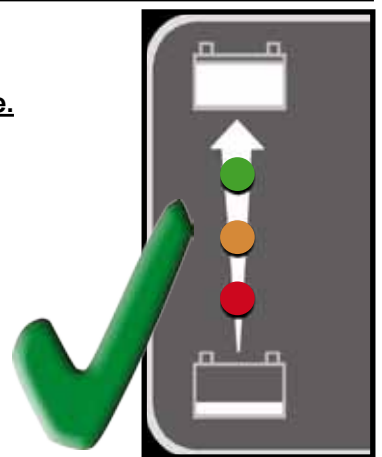

Under abnormal use;

i.e. leaving the machine without charging for a period of time, we advise that you disconnect the battery from the machine.

If the machine will be standing unused for a period of 30 days or more, then batteries must be fully charged

Note.

Batteries should be recharged every three months.  
Charge fully the day before you start using the machine again.

# Machine Charging

To ensure your machine remains at its maximum efficiency and prolong your battery life, please follow the simple steps below:

**Under normal daily usage:**

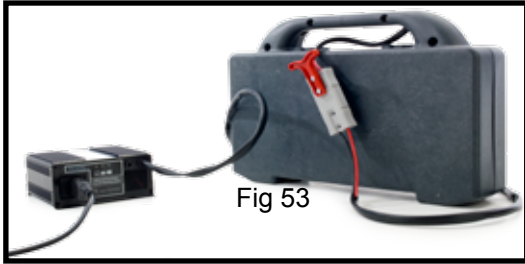

Fig 53

Recharge batteries after each use regardless of machine operation time (fig 53).

Connect the charger unit to the battery and plug the charger into a suitable power supply (Fig 53a).









Fig 53a

The battery charge state is shown by the light sequence on the front of the charger (fig 54).



Fig 54

Signal (LED)		Meaning
	Red LED on	First phase of charge in progress
	Yellow LED on	Second phase of charge in progress
	Green LED on	End of charge or maintenance phase Disconnect from power supply Switch power supply, OFF then ON, to restart the charging cycle
	Red LED flashing	Unsuitable battery or charging malfunction Safety timer exceeded Internal short circuit Disconnect from power supply Switch power supply, OFF then ON, to restart the charging cycle
	Yellow LED flashing	Battery not connected
INITIAL TEST		
	Green LED with 2 flashes	Battery charger configured for recharging Gel or AGM batteries
	Red LED with 2 flashes	Battery charger configured for recharging Lead-acid (Wet) traction batteries

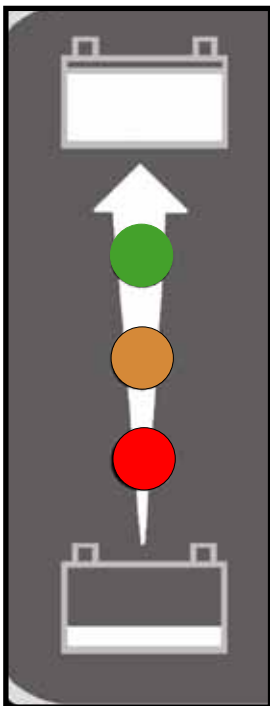

The battery meter displays the charge level of the batteries; when fully charged, all meter lights are illuminated (Fig 54).

As the machine is used and the batteries are discharged, the meter lights will go out from top to bottom.

If the battery-charge level is allowed to discharge to the point that only one red light remains illuminated, the operator should either replace or charge the battery.

The battery supplied for this machine allows for a run time of 45 mins approx (Lo Mode), when fully charged.

The battery pack must be fully discharged and recharged over a few cycles and brushes need to be worn in to achieve maximum efficiency.

Charge time is approximately 6 hours.

Spare replacement batteries are available from your supplier.

See TTB-516 Spares list for part numbers.

The TTB-516 come with its own stand-alone charger.

Insert the charging lead required for your country into the charger.

Connect the charger to a suitable power supply.

Once mains power is connected the red charging indicator will illuminate.

To ensure a full charge, the battery should be left for a period of 6 hrs.

Once fully charged, disconnect the charging lead from both the power supply and the machine.

# Trouble-Shooting

PROBLEM	CAUSE	SOLUTION
Machine will not operate	Missing or blown fuses Battery not connected Low battery charge	Fit or replace fuse (page 8) Connect battery (page 8) Charge batteries (page 19/21)
Vacuum will not operate	Vacuum not turned on	Turn on vacuum (page 17)
Poor water pick-up	Waste-water tank full Clogged / blocked vacuum hose Loose hose connections Debris basket filter clogged/blocked Separator filter clogged / blocked Poor separator seal Damaged separator seal Damaged / split vacuum hose Damaged floor-tool blades Low battery charge	Empty waste-water tank (page 17) Remove and clean (page 17) Push tight connections (page 17) Remove and clean (page 17) Remove and clean (page 17) Clean and refit (page 17) Renew (contact service dept) Renew (contact service dept) Renew (contact service dept) Recharge batteries (page 19 /21)
No brush / scrub function	No brushes fitted Brush overloaded	Check and fit (page 10) Reset machine (page 14 fig 27d)
Little or no water flow	Clean-water tank empty Clean-water tank filter blocked/ clogged Incorrect water flow setting	Fill clean-water tank (page 11) Remove and clean (page 17) Adjust tap as desired (page 14)
Machine just 'stops' while operating	To much load on the brush system  Blown fuse in Battery pack	Reset the machine and decrease the brush load to best suit the floor type (page 14. fig 27d) Replace 40 Amp fuse (page 18)

# Specifications

**Model TTB-516**

Brush Motor	Vac Motor	Brush Sizes	Pad sizes	Weight	Protection Class	Run Time per battery pack	Power	
<b>400W</b>	<b>24V 300W</b>	<b>16"</b>	<b>16"</b>	<b>52 Kg</b>	<b>IPX4</b>	<b>Hi - 35 mins Lo - 45 mins</b>	<b>2 x 12V (24V) 18Ahr</b>	
Area Performance per battery pack	Fluid Flow (Tap at 45')	Brush / Pad Pressure	Speed	Recharge time	Cleaning Speed	Hand Arm Vibration	Noise	Size
<b>1050m<sup>2</sup></b>	<b>0.09 gpm (60 mins)</b>	<b>27.4/ 26.2 g/cm2</b>	<b>Hi-150 rpm Lo-130rpm</b>	<b>6 hrs</b>	<b>0-4.2Kph</b>	<b>0.6 m/s<sup>2</sup></b>	<b>Hi-70.3 dB(A) Lo-68.2 dB(A)</b>	<b>850mmx 1132mmx 520mm</b>

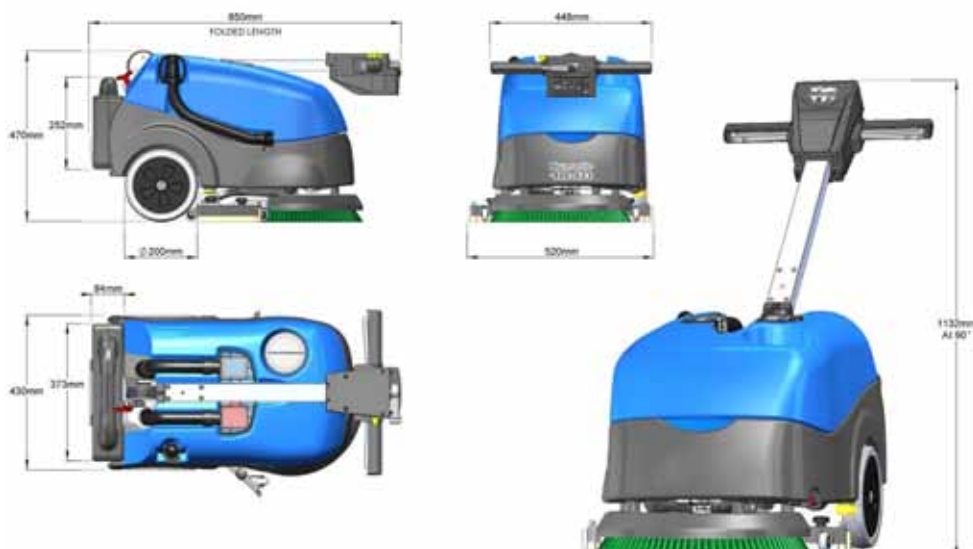

# Recommended Spare Parts - TTB-516

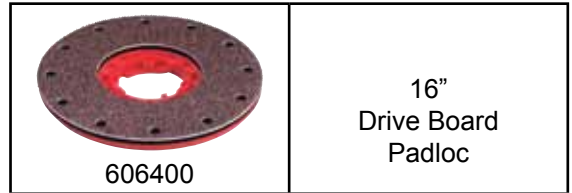
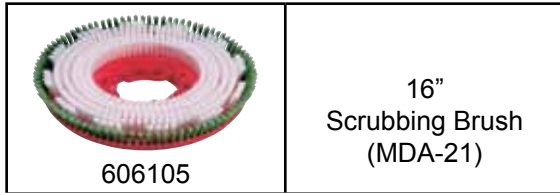

606260	TTB-516 BATTERY PACK (BOXED)	606261	TTB-516 REPLACEMENT BLADE SET
606266	TTB-516 BATTERY & CHARGER PACK (UK)	303985	TTB-516 FILLER CAP ASSEMBLY
606267	TTB-516 BATTERY & CHARGER PACK (EURO)	237268	FILLER CAP LID
606268	TTB-516 BATTERY & CHARGER PACK (SWISS)	237232	TTB-516 SEPERATOR FILTER
606269	TTB-516 BATTERY & CHARGER PACK (CSA)	237260	TTB-516 GRIT BASKET
606270	TTB-516 BATTERY & CHARGER PACK (SOUTH AFRICA)	231054	TTB-516 SUCTION HOSE
606271	TTB-516 BATTERY & CHARGER PACK (AUS)	213055	TTB-516 VAC HOSE
606272	TTB-516 CHARGER PACK (UK)	208471	CONSTANT TENSION CLIP
606273	TTB-516 CHARGER PACK (EURO)	303997	TTB-516 DUMP-HOSE ASSEMBLY
606274	TTB-516 CHARGER PACK (SWISS)	208448	TANK DRAIN CAP
606275	TTB-516 CHARGER PACK (CSA)	208526	REPLACEMENT 40AMP FUSE
606276	TTB-516 CHARGER PACK (SOUTH AFRICA)	208455	M5 KNOB (BLACK)
606277	TTB-516 CHARGER PACK (AUS)	208537	CONSTANT TENSION CLIP (VAC HOSE)

## NOTES

.....

.....

.....

.....

.....

.....

.....

.....

.....

.....

.....

.....

.....

.....

.....

.....

.....

.....

.....

.....

.....

.....

.....

.....

.....

.....

# TTB-516

DRW-7279 (A06) 06:08:2012

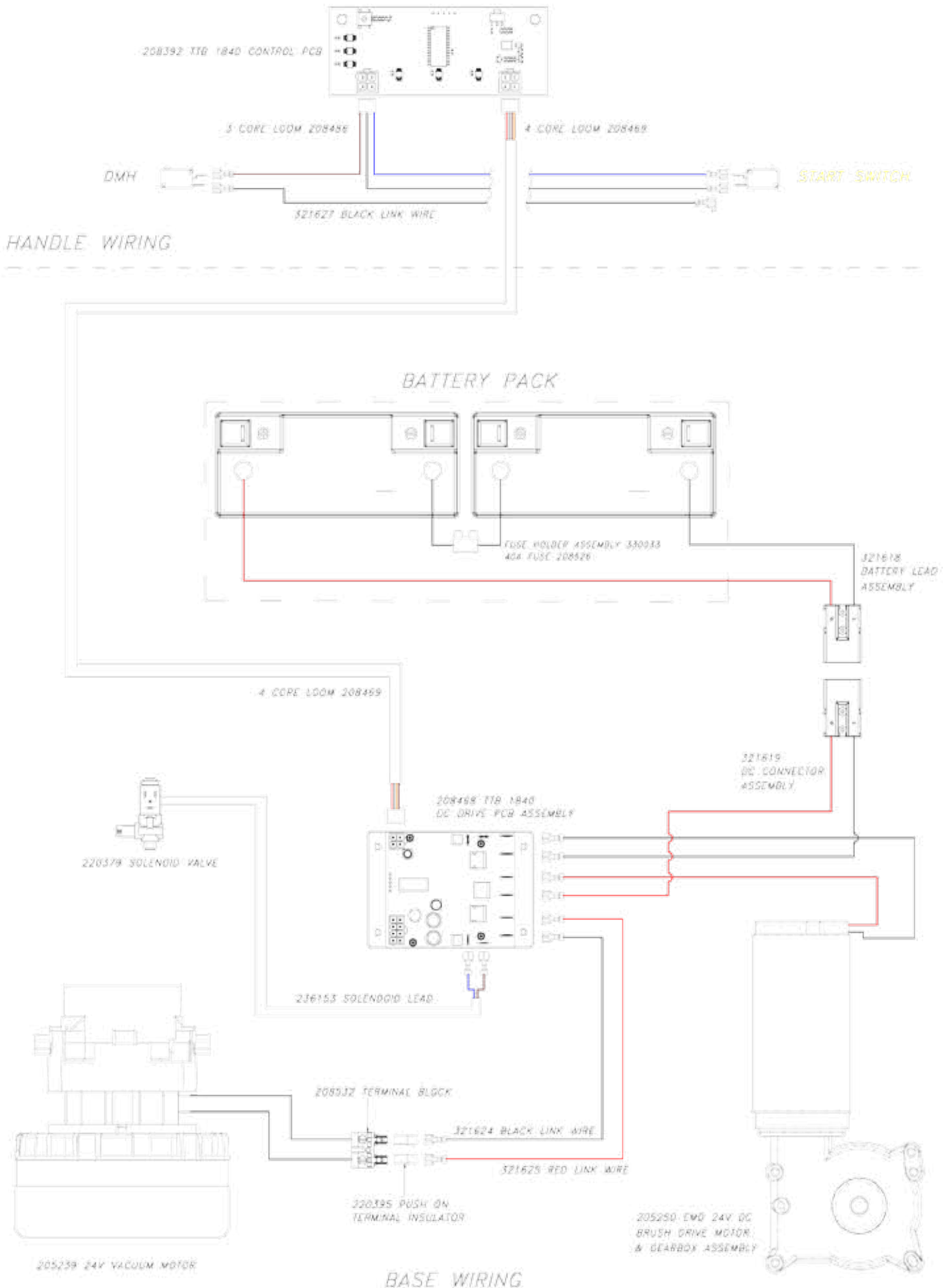



Affix Label Here

## Product serial number

This machine has been packed  
with the following

Charging Lead + Charger

Brush / Pad

Battery Pack

Floor Tool

Signed

Distributed by:



# NACECARE

1205 Britannia Road East  
Mississauga Ontario L4W 1C7  
Canada

Telephone: 9 00 1 905 795 0122

Fax: 9 00 1 905 795 0038

<http://www.nacecare.com>



Numatic International Limited, Chard, Somerset, TA20 2GB, ENGLAND.

Telephone 01460 68600 Fax: 01460 68458

[www.numatic.co.uk](http://www.numatic.co.uk)

*Specification subject to change without prior notice*

[www.numatic.co.uk](http://www.numatic.co.uk) © Numatic International Limited